

JVC

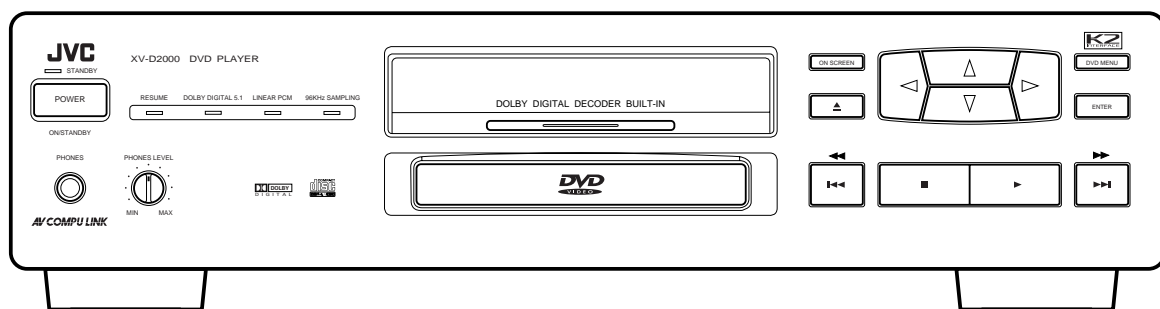

DVD PLAYER

XV-D2000BK

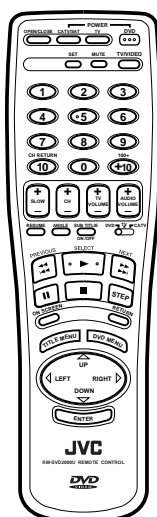

Video CD

PlayBack
Control



INSTRUCTIONS

For Customer Use:

Enter below the Model No. and Serial No. which are located on the rear, bottom or side of the cabinet. Retain this information for future reference.

Model No. _____

Serial No. _____

LET0091-001A

[J]

Warnings, Cautions and Others

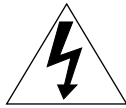
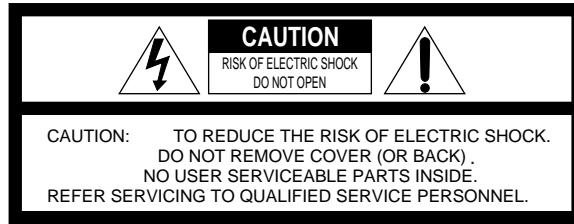

The lightning flash with arrowhead symbol within an equilateral triangle alerts the user to the presence of uninsulated "dangerous voltage" within the product's enclosure that could cause electric shock.



The exclamation mark within an equilateral triangle alerts the user to important operating and maintenance (servicing) instructions in the manual for the appliance.

For U.S.A.

This equipment has been tested and found to comply with the limits for a Class B digital device, pursuant to part 15 of the FCC Rules. These limits are designed to provide reasonable protection against harmful interference in a residential installation.

This equipment generates, uses and can radiate radio frequency energy and, if not installed and used in accordance with the instructions, may cause harmful interference to radio communications. However, there is no guarantee that interference will not occur in a particular installation. If this equipment does cause harmful interference to radio or television reception, which can be determined by turning the equipment off and on, the user is encouraged to try to correct the interference by one or more of the following measures:

Reorient or relocate the receiving antenna.

Increase the separation between the equipment and receiver.

Connect the equipment to an outlet on a circuit different from that to which the receiver is connected.

Consult the dealer or an experienced radio/TV technician for help.

WARNING: TO REDUCE THE RISK OF FIRE OR ELECTRIC SHOCK, DO NOT EXPOSE THIS APPLIANCE TO RAIN OR MOISTURE.

Caution — POWER switch!

Disconnect the mains plug to shut the power off completely. The POWER switch in any position does not disconnect the mains line. The power can be remote controlled.

IMPORTANT FOR LASER PRODUCTS

1. CLASS 1 LASER PRODUCT
2. **DANGER:** Invisible laser radiation when open and interlock failed or bypassed. Avoid direct exposure to beam.
3. **CAUTION:** Do not open the top cover. There are no user serviceable parts inside the player; leave all servicing to qualified service personnel.

CAUTION

To reduce the risk of electrical shocks, fire, etc.:

1. Do not remove screws, covers or cabinet.
2. Do not expose this appliance to rain or moisture.

Table of Contents

General Information	2	Audio CD Operations	35
Important cautions	2	Playing back from a desired track	35
Safety precautions	2	Resuming playback	35
Introduction	3	Playing back in a desired order	36
Introducing the XV-D2000BK	3	Repeating all tracks	37
Controls and functions	4	Repeating a single track	37
Supplied accessories	8	Repeating a desired part	38
Before Using for the First Time	9	Starting playback from a specified time	38
Before making any connections	9	Playing back only the beginning of each track	39
Connections	9	Playing back tracks in random order	40
Connecting with a TV.	9	Selecting the displayed time mode	40
Connecting with an audio amplifier or receiver	10	Video CD Operations	42
Connecting with an amplifier equipped with		Playing back from a desired track	42
Dolby Digital 5.1-channel inputs	11	Advancing a picture frame-by-frame	42
Connecting with an audio equipment with		Playing in slow-motion	42
digital input	12	Resuming playback	43
Connecting with a Dolby Digital decoder/amplifier		Playing back in a desired order	43
with built-in Dolby Digital decoder	13	Repeating all tracks	44
Connecting the power cord	14	Repeating a single track	45
Installing batteries in the remote control unit	14	Repeating a part	45
Preliminary Knowledge	16	Starting playback from a specified time	46
Playable discs by XV-D2000BK	16	Playing back only the beginning of each track	47
What are title, chapter and track?	16	Playing back tracks in random order	47
How to use numeric keys	17	Selecting audio channels	48
On-screen guide and invalid operation icons	18	Selecting picture character	48
On-screen displays	18	Checking total disc time	49
Screen saver function	20	Accessing the PBC function	49
Dolby Digital	21	Controlling Other Equipment	51
Basic Operations	22	Controlling TV	51
Playing back	22	Controlling CATV converter or satellite tuner	52
Selecting an item from a menu	23	Controlling a JVC amplifier or receiver	52
DVD Video Operations	24	Selecting Preferences	53
Displaying DVD menus	24	Preferences via "PREFERENCE" on-screen display	53
Locating a title	25	Setting Parental Lock	56
Selecting a chapter	25	Other Information	59
Starting playback from a specific time	26	Care and handling of discs	59
Advancing a picture frame-by-frame	26	Table of languages and their abbreviations	60
Playing in slow-motion	27	Manufacture's code list	61
Resuming playback	27	AV COMPULINK remote control system	62
Repeating a title	27	Troubleshooting	64
Repeating a chapter	28	Specifications	65
Repeating a desired part	29		
Changing the angle	30		
Subtitle on/off	30		
Changing the subtitle language	30		
Changing the audio	31		
Selecting picture character	32		
Down Mix	33		
Compression	34		

General Information

Important cautions

Installation of the player

- Select a place which is level, dry and neither too hot nor too cold (between 5°C and 35°C or 41°F-95°F).
- Leave sufficient distance between the player and a TV.
- Do not use the player in a place subject to vibrations.

Power cord

- Do not handle the power cord with wet hands!
- A small amount of power (5 watts) is always consumed while the power cord is connected to the wall outlet.
- When unplugging the player from the wall outlet, always pull the plug, not the power cord.

Malfunctions, etc.

- There are no user serviceable parts inside. If anything goes wrong, unplug the power cord and consult your dealer.
- Do not insert any metallic object into the player.

Safety precautions

Avoid moisture, water and dust

Do not place your player in moist or dusty places.

Avoid high temperatures

Do not expose your player to direct sunlight or place it near a heating device.

When you're away

When away on travel or otherwise for an extended period of time, pull the plug from the outlet.

Do not insert foreign objects into the player

Do not insert wires, hairpins, coins, etc. into your player.

Do not block the vents

Blocking the vents may damage your player.

Care of the cabinet

When cleaning your player, use a soft cloth and follow the relevant instructions on the use of chemically-coated cloths. Do not use benzene, thinner or other organic solvents and disinfectants. These may cause deformation or discoloring.

If water gets inside the player

Turn off the power switch and pull the plug from the electrical socket, then call the store where you made your purchase. Using the player in this state may cause a fire or electrical shock.

Introduction

Introducing the XV-D2000BK

DVD is the most innovative creation of audio and video technology. With the same physical size as the CD, DVD has much more storage capacity and can play back the finest images and sound. It also realizes revolutionary features such as multi-language capability, multi-angle function, etc.

The XV-D2000BK DVD player delivers the outstanding performance of DVD, thanks to JVC's advanced technology and sophisticated graphical user navigation system. The XV-D2000BK can also play back CDs and video CDs.

High quality video images

- Amazing color purity and sharpness with extremely low video distortion.
- Greater horizontal resolution than S-VHS or Laser disc.

High quality sound

- The newly developed K2 interface LSI delivers pure sound with no digital distortion.
- 1-bit DD converter that handles 20-bit, 96-kHz Fs audio signals and JVC's original PEM (Pulse Edge Modulation) circuit achieve more than double the resolution of conventional converters.
- By separating and isolating the power supplies for the analog and digital circuitry, the interference which causes digital noise to enter the analog system is eliminated.
- Separation of the circuits, PLL clock generators and power supplies for the audio unit and video unit improve sound quality.

Support for various DVD functions

Note: Each function below is available only if the DVD disc to be played back supports it.

- **Multi-language function**

Multi-language function for audio and subtitles. You can choose any combinations of audio and subtitle languages, such as English audio with subtitles, or audio with no subtitles.

- **Multi-angle function**

You can select from multiple camera angles of the same scene.

- **Parental lock**

You can restrict the playback of discs with scenes which you do not wish your child to see, such as adult or violent films.

- **Multi aspects**

Images can be viewed normally on a 4:3 (normal) television from a disc made for 16:9-screen (wide) televisions.

- **Dolby Digital**

The XV-D2000BK is fully equipped with Dolby Digital. It provides both optical and coaxial digital outputs for connection to an external Dolby Digital decoder, as well as 5.1 channel analog outputs for connection to an external AV amplifier equipped with 5.1 channel analog inputs.

Controls and functions

■ Front panel

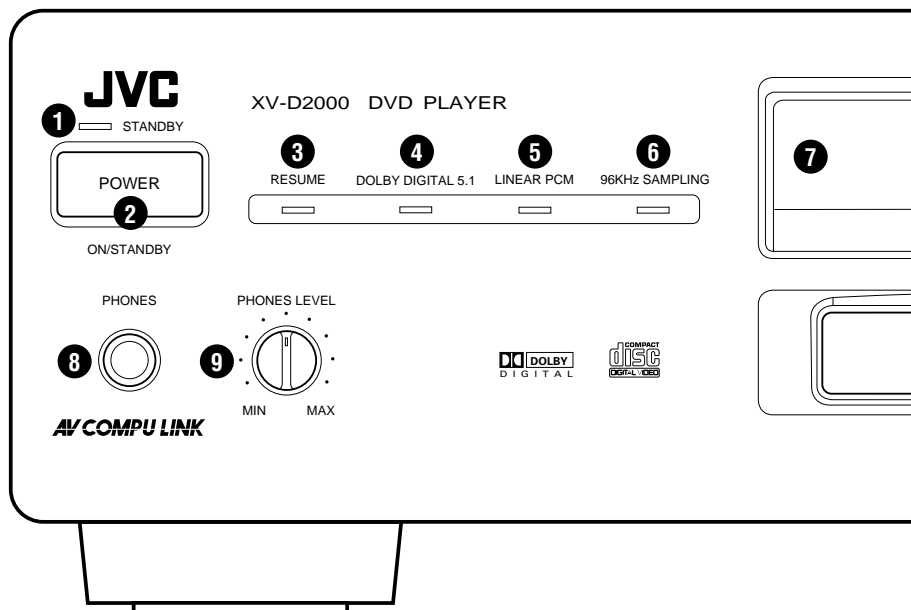

❶ STANDBY indicator

Lights when the power cord is connected and the player is at standby. When the player turns on, the STANDBY indicator goes off.

❷ POWER ON/STANDBY

Turns the player on or off (standby).

❸ RESUME indicator

Lights when a point to be resumed is stored.

❹ DOLBY DIGITAL 5.1 indicator

Lights when all the Dolby Digital 5.1-channel audio outputs (FRONT, REAR, CENTER, SUBWOOFER) on the rear panel are feeding signals.

❺ LINEAR PCM indicator

Lights when linear PCM audio is played back by DVD or CD.

❻ 96kHz SAMPLING indicator

Lights when the sampling frequency of linear PCM audio played back by DVD is 96kHz.

❼ Remote sensor

❽ PHONES

Connection terminal for headphones.

❾ PHONES LEVEL

Adjusts the listening level of headphones connected to the PHONES jack.

❿ Display

Indicates the current status of the player.

⓫ DVD indicator

Lights when a DVD disc is inserted. It blinks just after a disc is inserted.

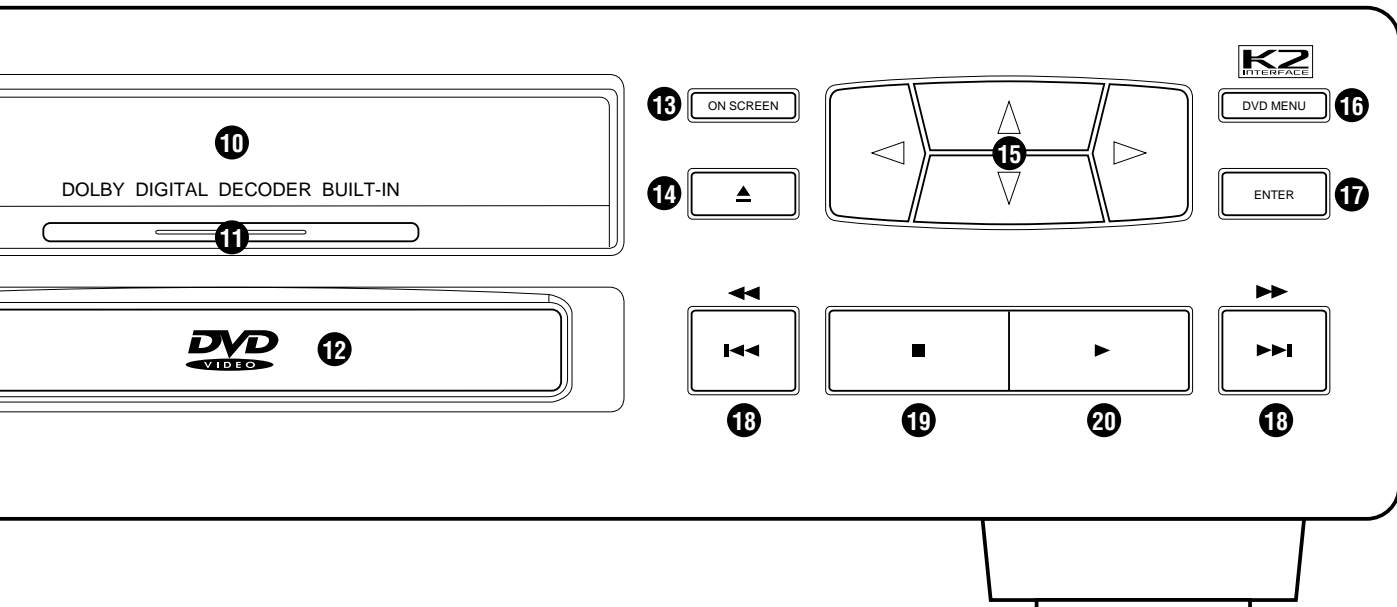
**12 Disc tray**

Used to load discs.

13 ON SCREEN

Displays an on-screen display of the player on the television screen or monitor. (See "On-screen displays" on page 18.)

14 ▲ (Open/Close)

Opens and closes the disc tray.

15 Δ/▽/▷/◁ (Cursor buttons)

Selects an item in on-screen displays or DVD menus.

16 DVD MENU

Displays a DVD menu on the television screen or monitor.

17 ENTER

Executes a selected item in a DVD menu or on-screen display.

18 ◀◀/◀, ▶▶/▶▶ (Skip/Search)

Performs skip, fast forward/backward, or previous/next.

19 ■ (Stop)

Stops playback.

20 ▶ (Play/Select)

Starts playback. Also, used a SELECT button for PBC of video CD.

■ Remote control unit

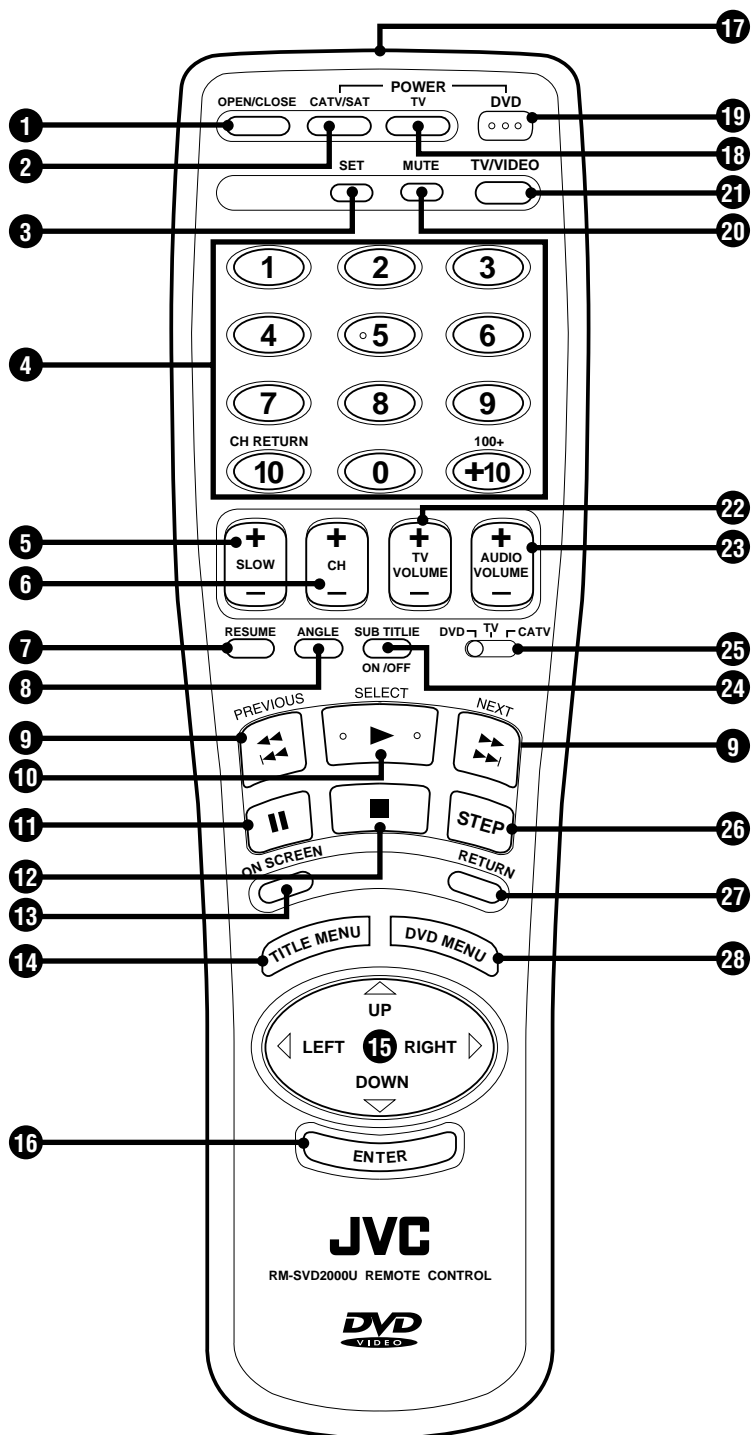

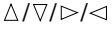
- 1 OPEN/CLOSE**
Opens and closes the disc tray.
- 2 POWER-CATV/SAT**
Turns the CATV converter or satellite tuner on or off.
- 3 SET**
Used to set the manufacturer's code for operating another manufacturer's TV, CATV or satellite tuner from the remote control unit.
(See "Controlling Other Equipment" on pages 51.)
- 4 Numeric keys**
Depending on the selection of DVD/TV/CATV switch, they are used for entering a title, track or chapter number, or selecting a TV channel.
- 5 SLOW** (for DVD/video CD)
Starts slowmotion playback.
(See "Playing in slow-motion" on pages 27 and 42.)
- 6 CH**
Changes the channels of TV or CATV converter/satellite tuner.
- 7 RESUME**
Stores the location to be resumed later.
(See "Resuming Playback" on pages 27, 35 and 43.)
- 8 ANGLE** (for DVD)
Changes camera angles during playback of a DVD shooting by multiple cameras.
(See "Changing the Angle" on page 30.)
- 9**  **(Skip/Search)**
Performs skip, fast forward/backward, or previous/next.
- 10**  **/SELECT**
Starts playback. Also, use as a SELECT button for PBC of video CD.
- 11**  **(Pause)**
Pauses during playback.
- 12**  **(Stop)**
Stops playback.
- 13 ON SCREEN**
Displays an on-screen display of the player on the television screen or monitor.
(See "On-screen displays" on page 18.)
- 14 TITLE MENU**
Displays a title menu of DVD on the TV screen.
- 15**  **(Cursor buttons)**
Selects an item in on-screen display, title menus or DVD menus.
- 16 ENTER**
Executes a selected item in a menu or on-screen display.
- 17 Infrared light-emitting window**
Point this window toward the remote sensor on the front panel when pressing buttons.
- 18 POWER-TV**
Turns the TV on or off.
- 19 POWER-DVD**
Turns the XV-D2000BK on or off (standby).
- 20 MUTE**
Turns the mute function of the TV on or off.
- 21 TV/VIDEO**
Switches input of the TV (either TV or VIDEO).
- 22 TV VOLUME**
Adjusts the TV volume.
- 23 AUDIO VOLUME**
Adjusts the volume of a JVC AV amplifier or receiver.
- 24 SUB-TITLE ON/OFF** (for DVD)
Turns on or off subtitles.
(See "Subtitle on/off" on page 30.)
- 25 DVD/TV/CATV**
Selects the function of the numeric keys to control the corresponding device.
- 26 STEP** (for DVD/video CD)
Advances pictures frame by frame.
(See "Advancing a picture frame-by-frame" on pages 26 and 42.)
- 27 RETURN** (for DVD/video CD)
Returns to the previous menu.
- 28 DVD MENU**
Displays a DVD menu on the television screen or monitor.
(See "Displaying DVD menus" on page 24.)

■ Rear panel

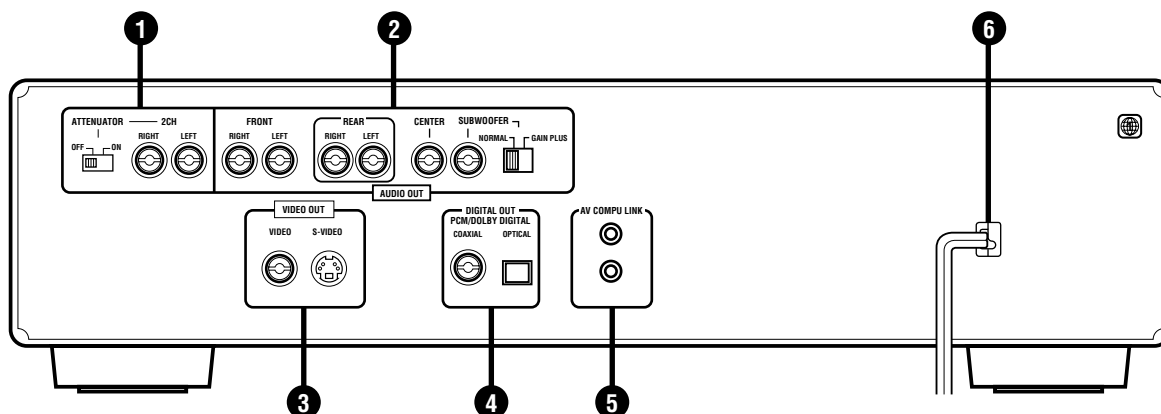

❶ AUDIO OUT (2CH)

2CH (RIGHT and LEFT) terminals output analog audio signals. ATTENUATOR switch attenuates the output level when it is set to ON.

❷ AUDIO OUT (5.1CH)

FRONT (RIGHT and LEFT), REAR (RIGHT and LEFT), CENTER, and SUBWOOFER terminals output Dolby digital 5.1ch. analog audio signals. SUBWOOFER switch boosts the SUBWOOFER signal when it is set to GAIN PLUS.

❸ VIDEO OUT

VIDEO outputs composite video signals, while S-VIDEO outputs S-video signals.

❹ DIGITAL OUT

Outputs digital audio signals. Both coaxial and optical connectors are provided.

❺ AV COMPU LINK

Connects with another JVC equipment supporting the AV Compulink to facilitate operations. (See "AV COMPULINK remote control system" on page 62.)

❻ AC POWER CORD

Connects to the wall outlet.

Supplied accessories

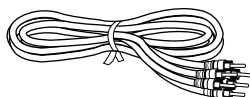

Audio/video cable (x 1)

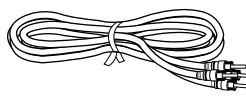

Audio Cable (x 3)

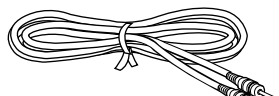

AV compulink cord (x 1)

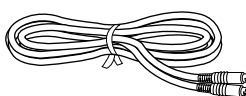

S-video cable (x 1)

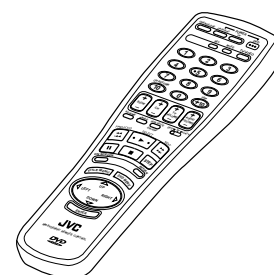

RM-SVD2000U Remote Control Unit (x 1)



R6P(SUM-3)/AA(15F) batteries (x 2) for RM-SVD2000U

Before Using for the First Time

Before making any connections

- Since different components often have different terminal names, carefully read the instruction manual supplied with the component you wish to connect.
- Do not connect the AC power cord until all other connections have been made.

Connections

■ Connecting with a TV

You can enjoy the XV-D2000BK by simply connecting it with a television set. To hear audio sound with better quality, connect the audio outputs with your audio equipment. (See the following pages.)

Note: Be sure not to plug in the power cord until all other connections have been made.

The XV-D2000BK can be connected directly to a television set equipped with stereo audio input and video input jacks using the supplied audio/video cables.

If your television set has a monaural audio input instead of stereo, you need to use an optional audio cable which converts stereo audio output to monaural.

If your television set has an S-video input, we recommend you to connect it with S-VIDEO of the player using the supplied S-video cable, in addition to the (standard) video connection, to get a better picture quality.

Connect VIDEO OUT of the player with the video input of a television set. Connecting VIDEO OUT of the player to a TV via a VCR may cause a monitor problem when playing back a copy-protected disc.

The ATTENUATOR switch beside the 2CH audio outputs should be normally set to OFF. If you hear the audio distorted because the sensitivity of the TV's audio input is too high, set the ATTENUATOR to ON.

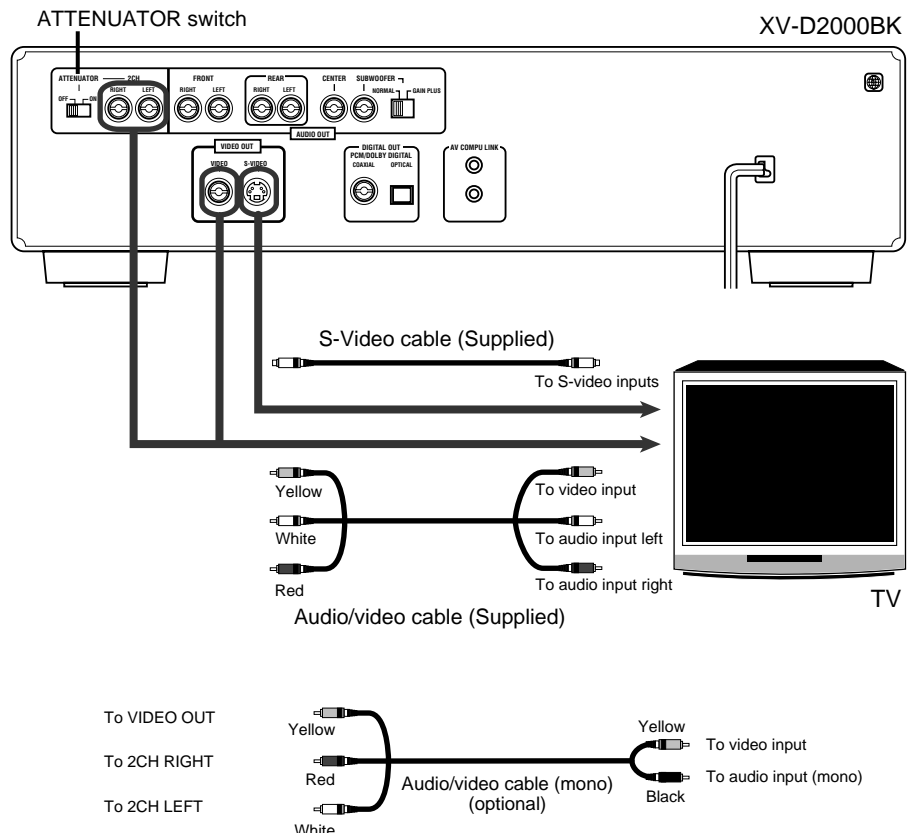

Before Using for the First Time

■ Connecting with an audio amplifier or receiver

You can enjoy high-quality audio by connecting the player's audio outputs (2CH) to your amplifier or receiver.

Note: Be sure not to plug in the power cord until all other connections have been made.

Connect the player's AUDIO OUT (2CH) to any line-level inputs (such as AUX, DVD, CD, etc.) of an audio amplifier or receiver.

The ATTENUATOR switch beside the 2CH audio outputs should be normally set to OFF. If you hear the audio distorted because the sensitivity of the amplifier's line input is too high, set the ATTENUATOR to ON.

If the "DOWN MIX" item in the DVD on-screen display is set to "OFF", you may not be able to get the proper audio signal from the player's 2CH outputs when playing back a DVD disc with Dolby Digital 5.1-channel audio. (See "Down Mix" on page 33)

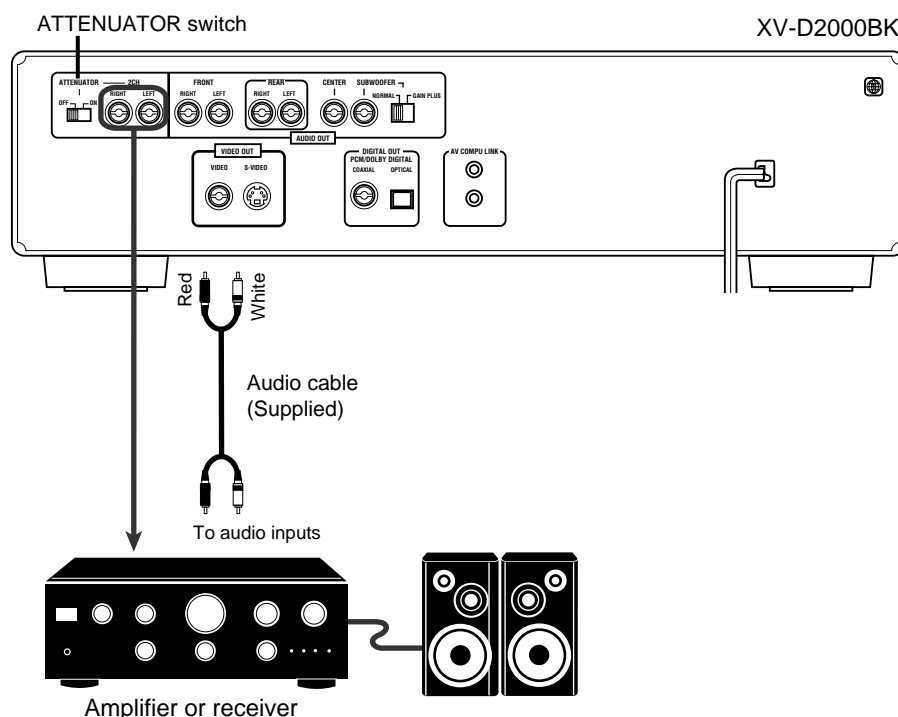

■ Connecting with an amplifier equipped with Dolby Digital 5.1-channel inputs

Connect the player's 5.1-channel outputs (FRONT-RIGHT/LEFT, REAR-RIGHT/LEFT, CENTER, and SUBWOOFER) to the Dolby Digital 5.1-channel inputs of an amplifier using audio cables. Be sure to connect correctly between corresponding terminals.

- Notes:**
- When using 5.1-channel outputs, you have to set some preferences (CENTER SPEAKER, SURROUND SPEAKERS and BASS REDIRECT) in the "PREFERENCE" display. (See "Preferences via "PREFERENCE" on-screen display" on page 53.)
 - The subwoofer output level can be selected between NORMAL and GAIN PLUS by the SUBWOOFER switch. Normally it should be set to NORMAL but to enhance the low frequency, set it to GAIN PLUS.
 - You can connect the audio outputs from the player to both a Dolby surround system and a TV via the 5.1-channel and 2-channel outputs. However, be sure to set DOWN MIX in the DVD on-screen display correctly according to the playback system (surround system or TV) when playing back a Dolby Digital 5.1-channel source. Otherwise, audio is not played back correctly. (See "Down Mix" on page 33.) Therefore, you cannot get proper audio from both the 2-channel and 5.1-channel outputs.

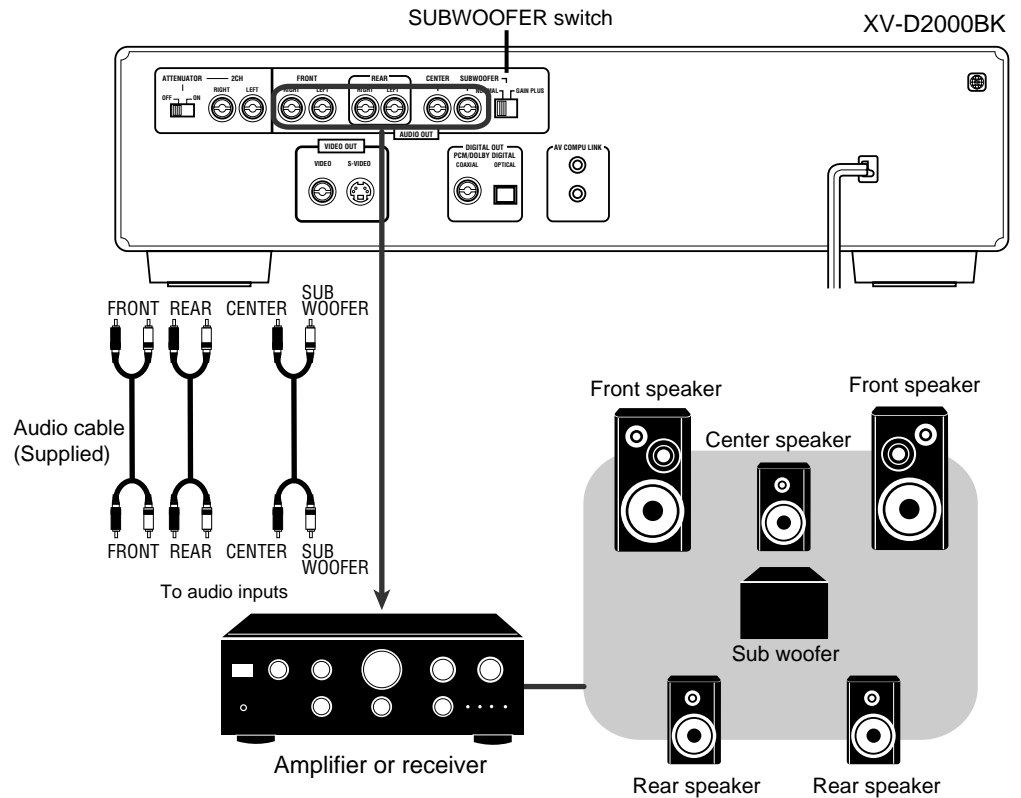

Before Using for the First Time

■ Connecting with an audio equipment with digital input

By connecting the player's DIGITAL OUT (coaxial or optical) with the digital input of an amplifier, DAT or MD using a digital cable, the digital stereo audio signal in a disc is directly transferred.

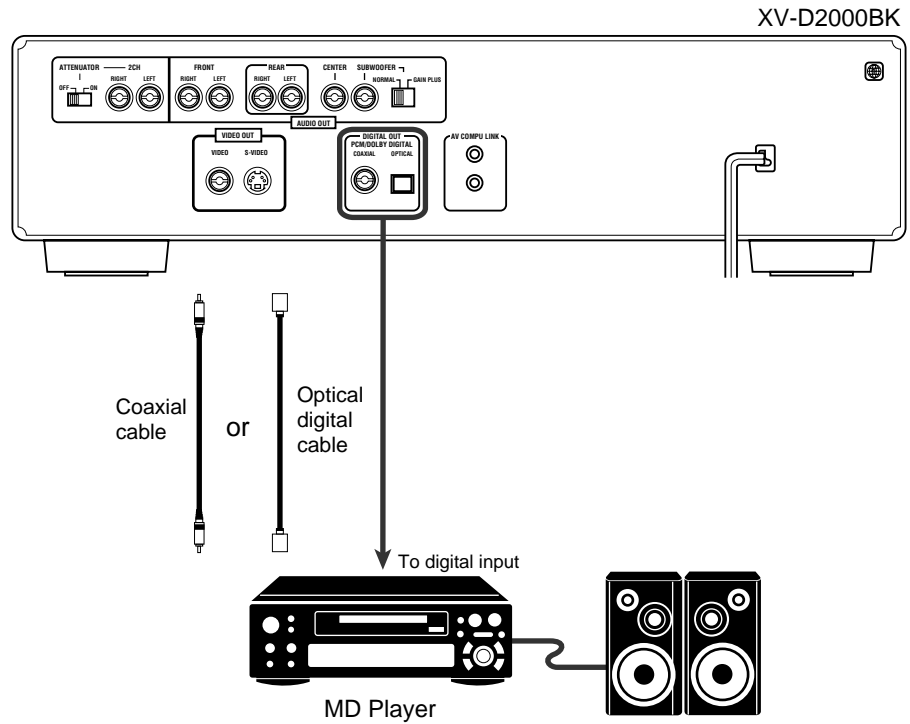

- Note:**
- Before actual usage, set "DIGITAL AUDIO OUTPUT" in the "PREFERENCE" display to "PCM ONLY," otherwise, playing back a Dolby Digital encoded DVD may generate noise and, in the worse case, damage your speakers. See "Preference via "PREFERENCE" on-screen display" on pages 53.
 - Set "DOWN MIX" setting in the DVD on-screen display to "L0/R0" or "Lt/Rt". (See "Down Mix" on page 33.)

■ Connecting with a Dolby Digital decoder/amplifier with built-in Dolby Digital decoder

Connect the player's DIGITAL OUT (coaxial or optical) to the digital input of a Dolby Digital decoder or an amplifier with built-in Dolby Digital decoder using an optional digital cable.

- Notes:**
- Before actual usage, set "DIGITAL AUDIO OUTPUT" in the "PREFERENCE" on-screen display to "PCM/AC-3". See "Preference via "PREFERENCE" on-screen display" on pages 53.
 - With this connection, the player's settings for COMPRESSION, DOWN MIX, CENTER SPEAKER, SURROUND SPEAKERS and BASS REDIRECT are invalid. Settings for these items must be done in the decoder.

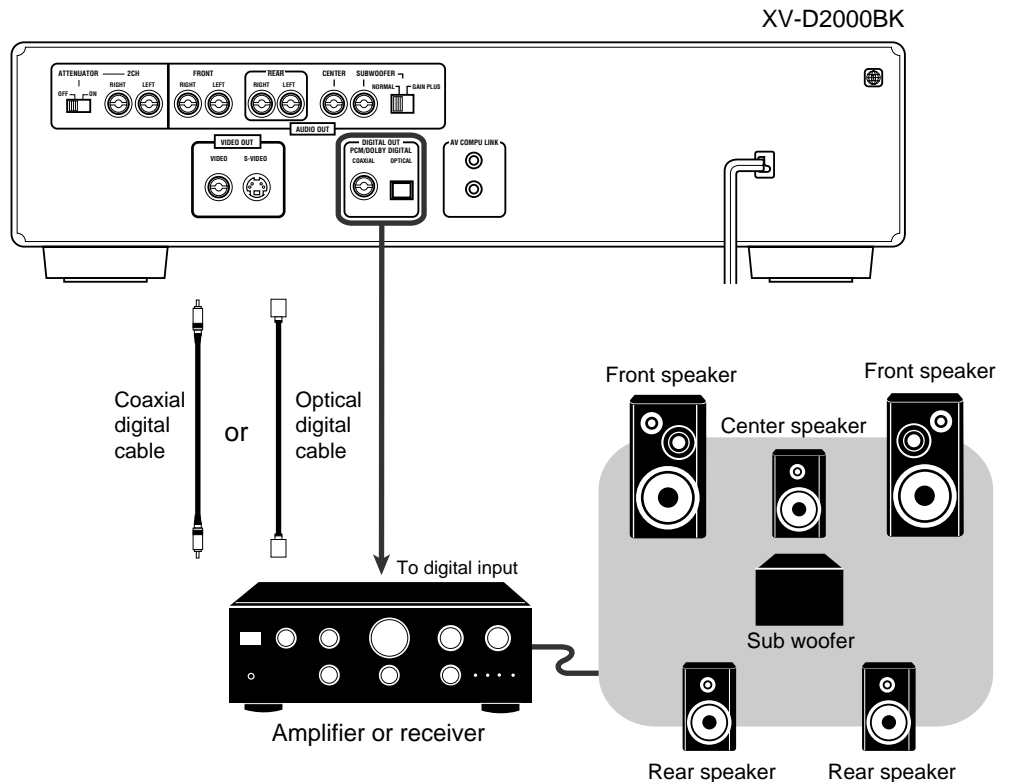

Before Using for the First Time

Connecting the power cord

When all the connections have been made, insert the power plug into the wall outlet firmly. The STANDBY indicator lights and the setup is completed.

Warning

- Disconnect the power cord if you are not going to use the player for a long time.
- Disconnect the power cord before cleaning the player.
- Disconnect the power cord before moving it.
- Do not connect or disconnect the power cord with wet hands.
- Do not pull the power cord when disconnecting it, as this may damage the cord and cause fire, electric shock, or other accidents.

Caution

- Do not damage, remodel, twist, or pull the power cord, as this may cause fire, electric shock, or other accidents.
- Contact a dealer and get a new power cord if the cord is damaged. A damaged cord may cause fire, electric shock, or other accidents.
- Do not put anything heavy or this player on the power cord, as this may cause fire, electric shock, or other accidents.

Installing batteries in the remote control unit

The battery compartment is located on the back of the remote control unit.

1. Press down on the triangular mark of the compartment cover, and pull up the cover to open the compartment.

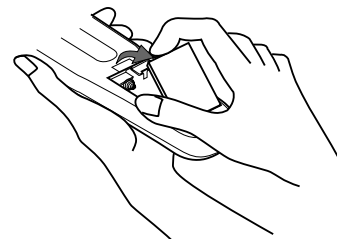

2. Place the two accessory R6P (SUM-3)/AA(15F) batteries in the remote control according to the polarity markings ("+" and "-") inside the compartment and on the batteries.

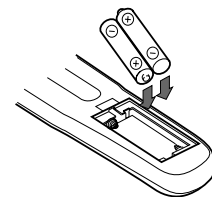

3. Place the cover over the compartment, and press down lightly.

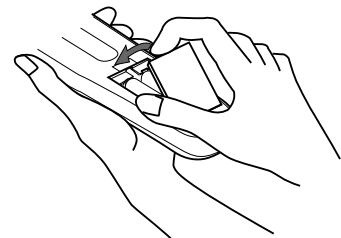

Before Using for the First Time

The batteries will last about one year with normal use. If the functions of the remote control become erratic, replace the batteries. See "Precautions for the safe use of batteries" below for more information.

Precautions for the safe use of batteries

Observe the following precautions for the safe use of batteries. If they are used improperly, their life will be shortened, they may burst or their contents may leak.

- Remove the batteries from the remote control if it is not going to be used for a long period of time.
- Remove dead batteries and dispose of them properly.
- Never leave dead batteries lying around, take them apart, mix them with other refuse, or throw them into an incinerator.
- Never touch liquid that has leaked out of a battery.
- Do not mix new and old batteries, or batteries of different types, when replacing them.

Preliminary Knowledge

Playable discs by XV-D2000BK

The XV-D2000BK can play back DVD video, video CD and audio CD discs.



- DVD players and DVD discs have their own numbers describing the region(s) where they can be played by retail areas. These numbers are called "Region Codes." The Region Code for this unit is "1", so any discs whose Region Codes is not "1" cannot be played.

Examples of playable DVD discs



- This unit is designed to use the NTSC system.
- Any other discs than listed above (CD-ROM, Photo CD, etc.) cannot be played. Playing back such discs may generate noise and damage speakers.
- Sound of CD-G discs are playable but pictures are unplayable.
- Do not play back CD-R discs. Playing back a CD-R disc may damage the contents of the disc.

What are title, chapter and track?

A DVD disc comprises "titles," while an audio CD or video CD comprises "tracks." Each title may be divided into some "chapters." For example, if a disc contains some movies, each movie may have its own title number, and each movie may be divided into some chapters. In a karaoke disc, each song usually has its own title number and does not have chapters. In general, each title has an independent content, while each chapter in the same title has continuity.

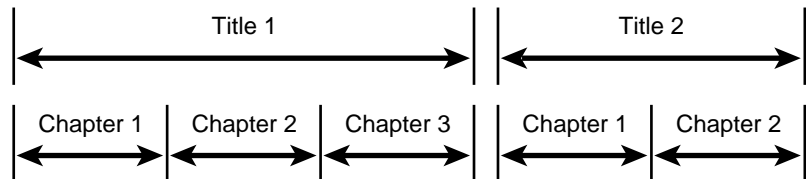

For a DVD

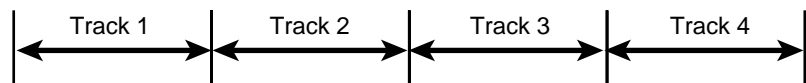

For an audio CD

How to use numeric keys

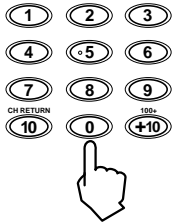

According to the setting of the DVD/TV/CATV switch, the numeric key functions differ.

■ When setting the DVD/TV/CATV switch to "TV"

The numeric keys select TV channels.

■ When setting the DVD/TV/CATV switch to "CATV"

The numeric keys select channels of a CATV converter or satellite tuner.

■ When setting the DVD/TV/CATV switch to "DVD"

The numeric keys are used to select a track or title number, or to enter a specific time or chapter number.

1) To select a track or title number directly using numeric keys

- **To select a number between 1 and 10 ...**
Press the corresponding key(s) for the number.
- **To select a number higher than 10 ...**
Use the +10.

Example 1: To select 13

+10 → 3

Example 2: To select 35

+10 → +10 → +10 → 5

Example 3: To select 40

+10 → +10 → +10 → 10

2) To enter a specific time or chapter number via on-screen displays

Press the corresponding numeric keys for a desired time or number from left to right digits, then ENTER.

Example 1: To enter 10:52

1 → 0 → 5 → 2 → ENTER

Example 2: To enter chapter number 14



1 → 4 → ENTER

- If you enter a wrong number, enter zeros until the wrong number disappears, then reenter the correct numbers.

On-screen guide and invalid operation icons



■ On-screen icons

During DVD playback, you may see icons displayed over the picture. These have the following meanings.

-  : Displayed at the beginning of a scene recorded from multiple angles. (See "Changing the angle" on page 30.)
-  : Displayed at the beginning of a scene recorded with multiple audio languages. (See "Changing the audio" on page 31.)
-  : Displayed at the beginning of a scene recorded with multiple subtitles. (See "Changing the subtitle language" on page 30.)

You can set not to display on-screen icons above via the preference settings described on pages 53.

■ Invalid operation icon

When you press a button, if the XV-D2000BK does not accept its operation,  appears on your television screen. Operations are occasionally unacceptable even if  is not displayed.

Note that some operation may not be accepted. For example, some discs may not allow fast forward, fast backward or slow-motion playback.

On-screen displays

The player provides several On-Screen Displays shown below for choosing preferences for initial settings and functions which are not frequently used in most cases.



Opening display



DVD during playback

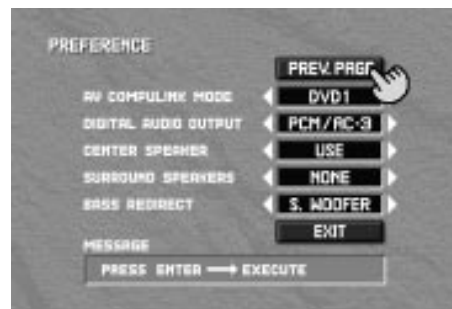

For preferences



CD (For CD during playback or stop and for video CD during stop)





For video CD (during playback)







For DVD parental lock settings

To access on-screen displays, press ON SCREEN (Note that operation for accessing the "Parental Lock" on screen displays is different.). Depending on the type of disc inserted (or "no disc") and the player's mode, a proper on-screen display is accessed. See "Setting Parental Lock" on pages 56.

 appears at the on-screen display. You can move  using $\Delta/\nabla/\triangleright/\triangleleft$.  is used to select items you want to work with.

Basic operations in the on-screen display are as follows.

- With an item like , you can change the setting with $\triangleleft/\triangleright$ by placing  on it.
-  - type item works when you place  on the item and press ENTER.
- In the message box,  indicates the operation to be done.
- Numbers are entered using numeric keys.
- Some functions become effective by pressing the ENTER button after specifying necessary entries.
- Pressing ON SCREEN again exits the on screen display.

Dolby Digital

Dolby Digital is a surround system using the digital audio compression technology developed by Dolby Laboratories Licensing Corporation. It is configured with six channels and reproduced by a speaker system including front (L and R), rear (L and R), center and sub-woofer. Because a sub-woofer in this system is an auxiliary speaker, this system is called "5.1 channel system".

In a DVD video disc, the surround audio data is recorded digitally in a bit-stream. This information is separated into up to 6 (analog) audio channel signals by a decoder, which are reproduced by up to 6 corresponding speakers via a 6-channel amplifier. A disc encoded with Dolby Digital displays the symbol. Note that not all Dolby Digital encoded DVD video discs contain 6 channel signals. Some may contain only L and R, while the others L, R and rear.



■ The XV-D2000BK fully supports Dolby Digital.

* Built in Dolby Digital decoder and equipped with 5.1ch. outputs.

You do not need an external Dolby Digital decoder. The player decodes Dolby Digital signal internally and outputs decoded analog signals from the 5.1 channel outputs, which are to be connected directly to an 6-channel amplifier equipped with 5.1 channel inputs. (See "Connecting with an amplifier equipped with Dolby Digital 5.1-channel inputs" on page 11)

* Displaying playback Dolby Digital Channels

The front panel display indicates Dolby Digital channels being played back.

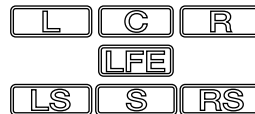

- L, R: for front (L, R) speakers
- LS, RS: for rear (L, R) speakers
- C: for a center speaker
- LFE: for a sub-woofer
- S: for rear speakers (monaural)

* Down Mix selection

Depending on the audio system for playback, you can select the optimum stereo mix signals. (See "Down Mix" on page 33)

* Selections/settings for 5.1-channel output signals

- Sub-woofer output level selection
You can boost the sub-woofer output level to enhance the low frequency range. (See "Rear panel" on page 8)
- Selections for Compression (See "Compression" on page 34)
You can select whether or not compressing the dynamic range when playing back with a 5.1-channel surround system. With no compression, you can enjoy a dynamic sound DVDs provide. However, we recommend to compress if you enjoy with low sound level.
- Settings for Center speaker, Surround speakers and Bass redirect
(See "Preferences via "PREFERENCE" on-screen display" on page 53)
According to your speaker configuration, you can get the optimum sound balance.

* Manufactured under license from Dolby Laboratories Licensing Corporation. DOLBY, the double-D symbol  and "AC-3" are trademarks of Dolby Laboratories Licensing Corporation.

Basic Operations

This chapter explains the basic playback common for DVD, audio CD and video CD. The illustrations in the left column here show the buttons of the remote control unit to be operated, however, you may use the corresponding buttons on the front panel of the player.

Playing back



1. Press OPEN/CLOSE to open the disc tray.
2. Place the disc in the tray with the label side up.

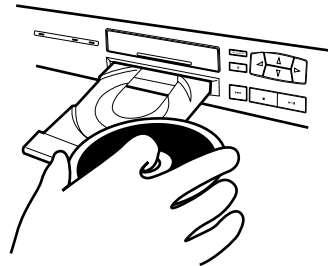

Notes: When loading a disc in the tray, be sure to position the disc inside the recess. Otherwise, the disc may be damaged when the tray is closed, and the disc may not be removed from the player.

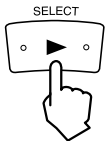

3. Press ► to close the tray.

The player starts playback from the beginning of the disc.

If a menu appears:

Refer to "Selecting from menu items" on the next page.

To stop playback:

Press ■.

To pause playback:

Press ■■. Pressing ► resumes playback.

To move fast forward or fast backward:

Hold down ◀◀/▶▶ or ▶▶/▶▶. Releasing the button returns the player to the normal playback mode.

* Both fast forward and fast backward move slowly for a while and then quickly thereafter.

* During fast forward or fast backward with a DVD disc or video CD, no audio is output.

If it seems that the picture's vertical/horizontal ratio is not correct when playing back a DVD video disc, set the MONITOR TYPE in the PREFERENCE display correctly. See "Preferences via "PREFERENCE" on-screen display" on page 53.

Some functions like fast forward or fast backward are disabled because of the recording method of DVD discs. In this case, the functions do not work even if the operations are done.

Selecting an item from a menu

With some DVD and video CD discs, a menu may appear automatically after inserting a disc or manually during playback or stop.



Example of menu

■ For DVD videodisc

To select an item in the menu:

1. Select a desired item using $\Delta/\nabla/\triangleright/\triangleleft$, then press ENTER. The player starts playback of the selected item.

With some discs, you can select the item by entering the corresponding number using the numeric keys, causing the player to automatically start playback.

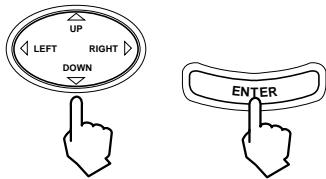

■ For video CD

1. Press the numeric button corresponding to a desired item. The player automatically starts playback.

* If you can see "NEXT" or "PREVIOUS," or equivalents in the menu, pressing $\blacktriangleleft/\blacktriangleleft$ or $\blacktriangleright/\blacktriangleright$ usually turns the menu pages.

* Pressing "RETURN" returns to the previous menu.

The operation procedure may be different depending on discs. Read the manual for the discs and follow the procedure indicated in the menu.

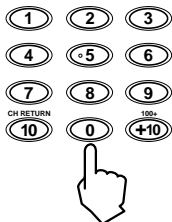

DVD Video Operations

This chapter explains all the functions of the player for playing back DVD discs. You can enjoy DVD in various ways, some of which only DVD can offer. Read "Basic Operations" on pages 22 and 23 before reading this chapter.

Displaying DVD menus

Most DVD discs have their own menus for selecting an item (title or chapter) to be played. A menu may be displayed automatically after inserting a disc or manually during playback or stop.



■ To access a title menu

1. Press TITLE MENU.

A title menu appears.

See "Selecting an item from a menu" on page 23, as well as the operation manual of the disc, for details of menu operations.

If appears when pressing the TITLE MENU button:

The disc does not contain a title menu.

Pressing TITLE MENU again turns off the menu and resumes playback from the previous scene.



■ To access a DVD menu

1. Press DVD MENU.

A DVD menu appears.

See "Selecting an item from a menu" on page 23, as well as the operation manual of the disc, for details of menu operations.

If appears when pressing the DVD MENU button:

The disc does not contain any DVD menu.

Pressing DVD MENU again turns off the menu and resumes playback from the previous scene.

Locating a title

You can locate a title you want to see by selecting a title number.

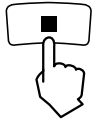

1. Press ■ to stop the disc.



2. Press the corresponding numeric keys for a desired title.
The player starts playback of the title.

If  appears when pressing numeric key(s):

The disc does not contain the corresponding title.

Selecting a chapter

You can specify a chapter to be played back using the on-screen display.

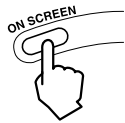

1. Press ON SCREEN during playback.
The on-screen display appears.

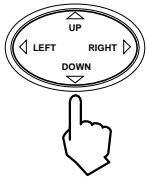

2. Move  to "CHAP. SEARCH" using the Δ/∇ .
The message box indicates "GO TO CHAPTER: ".

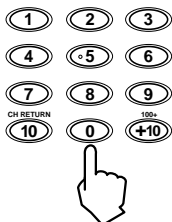

3. Enter a desired chapter number using the numeric keys.
See page 17 for details about how to use the numeric keys.



4. Press ENTER.
The player starts playback from the selected chapter.

If  appears when pressing ENTER:

The disc does not contain chapters, or prohibits the chapter search function.

To turn off the on-screen display:

Press ON SCREEN.

Starting playback from a specific time

If a DVD disc has time information (such a disc indicates the time in the display on the front panel), you can specify the time to start playback.

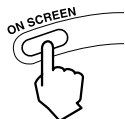

1. Press ON SCREEN during playback.
The on-screen display appears.

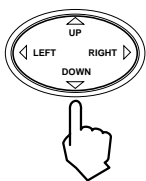

2. Move  to the "TIME SEARCH" using Δ/∇ .
The message box indicates "GO TO : : :".



3. Enter a desired time using the numeric keys.
See page 17 for details about how to use the numeric keys.

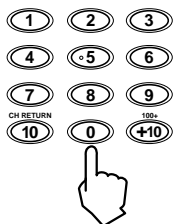

4. Press ENTER.
The player starts playback from the specified time.



If appears when pressing ENTER:

The disc does not contain time code or specified time, or prohibits the time search function.

To turn off the on-screen display:

Press ON SCREEN.

Advancing a picture frame-by-frame

You can advance a still picture frame-by-frame.

1. Press STEP during playback.
The player pauses.
Each time you press STEP, the picture advances one frame.



Pressing \blacktriangleright returns the player to normal playback.

- * The audio is muted during frame-by-frame playback.
- * You cannot backward a picture frame-by-frame.

Playing in slow-motion

You can playback a disc in slow-motion.



1. Press SLOW "+" during playback.
The playback speed slows down to half the normal speed.

Thereafter, each press of SLOW "+" slows the speed down to 1/3, 1/4, 1/8, 1/16 and 1/32 of the normal speed.

Pressing SLOW "-" speeds up in reverse order of the above.

Pressing ► returns the player to normal playback.

- * Audio is muted during slow-motion playback.
- * When the picture is being played back at 1/32 of the normal speed (which is the slowest), the SLOW "+" button is not effective.
Similarly, "-" button is not effective during 1/2 speed playback.
- * Pressing STEP or ■ in slow-motion mode freezes the motion.

Resuming playback

The player can memorize a position on a disc you want to interrupt playback and resume playback from that position later.

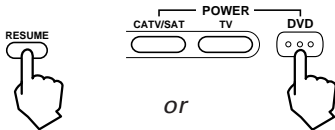

■ Memorizing a position

1. During playback, Press RESUME, or press POWER to turn off the power (STANDBY).
The player memorizes the current playback position of the disc, and the RESUME indicator on the front panel lights.

To clear the memory:

Take out the disc from the disc tray.

- * The last memory overrides the previous memory.

■ Resuming playback

1. Press RESUME when the disc is stopped or the power is off (STANDBY).

The player will locate the memory position and resume playback.



Repeating a title

You can repeat playback of the current title.

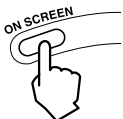

1. Press ON SCREEN during playback.
The on-screen display appears.

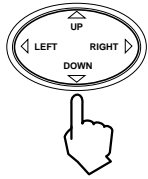

2. Move  to "REPEAT" using Δ/∇ .



3. Press ENTER once.
The message box indicates "TITLE REPEAT".
The current title will be repeated.

If  appears when pressing ENTER:

You cannot repeat the title because of the disc contents.

To turn off the on-screen display:

Press ON SCREEN.

Pressing it again turns on the on-screen display again.

To quit Title Repeat:

Press ■.

The player stops playback and quits the title repeat mode.

If you want to quit the title repeat mode but do not want to interrupt playback, move  to "REPEAT" in the on-screen display and press ENTER twice. "REPEAT" returns to its original color.

Repeating a chapter

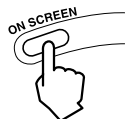

You can repeat a current chapter.

1. Press ON SCREEN during playback.
The on-screen display appears.

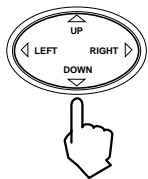

2. Move  to "REPEAT" using Δ/∇ .



3. Press ENTER twice.
The current chapter will be repeated.
The message box indicates "CHAPTER REPEAT".

If  appears when pressing ENTER:

You cannot repeat the chapter because of the disc contents.

To turn off the on-screen display:

Press ON SCREEN.

Pressing it again turns on the on-screen display again.

To quit Chapter Repeat:

Press ■.

The player stops playback and quits the chapter repeat mode.

If you want to quit the chapter repeat mode but do not want to interrupt playback, move  to "REPEAT" in the on-screen display and press ENTER once. "REPEAT" returns to its original color.

Repeating a desired part

You can repeat a desired part in the current title.

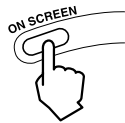

1. Press ON SCREEN during playback.
The on-screen display appears.

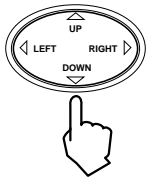

2. Move  to "A-B REPEAT" using Δ/∇ .



3. At the beginning of the desired part (point A), press ENTER.
4. At the end of the desired part (point B), press ENTER.
The player locates "A" and starts playback between "A" and "B" repeatedly.



To quit A-B Repeat:

Press ■.

The player stops playback and quits the A-B repeat mode.

If you want to quit the A-B repeat mode but do not want to interrupt playback, move  to "A-B REPEAT" in the on-screen display and press ENTER.

If  appears when pressing ENTER:

You cannot execute the A-B Repeat because of the disc contents.

To turn off the on-screen display:

Press ON SCREEN.

Pressing it again turns on the on-screen display again.

Changing the angle



Some DVD discs may have “multi-angle” parts, in which multiple cameras were used to shoot the same scene from different angles. You can select one of these angles during playback.

1. Press ANGLE on the remote control unit.
Each time you press the button, the angle changes in numerical order.
The ANGLE function is effective only when the current playback scene is recorded from multiple angles.

Example: Selecting from three different angles

Initial setting: angle 1 → Press ANGLE once: angle 2 → Press it again: angle 3 → Press it again: angle 1

If appears when pressing ANGLE:

The current scene is not recorded from multiple angles.

- * You can also select the angle via the “ANGLE” in the on-screen display.
 1. Press ON SCREEN during playback.
 2. Move  to “ANGLE” using Δ/∇ .
 3. Change the angle number using $\triangleleft/\triangleright$.

The current angle number and the total number of recorded angles are displayed in the box.

Example: 

- 1: current angle number
- 3: total number of recorded angles

Subtitle on/off



You can select whether or not subtitles are displayed.

1. Press SUBTITLE ON/OFF on the remote control unit.
The ON/OFF status is switched.
- * Subtitles cannot be displayed unless a DVD includes subtitles.
 - * With some discs, subtitles are always displayed and SUBTITLE ON/OFF does not work.

Changing the subtitle language

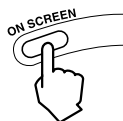

You can choose the subtitle language from among the languages included on a disc during playback.

1. Press ON SCREEN during playback.
The on-screen display appears.

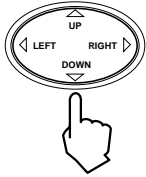

2. Move  to "SUBTITLE" using Δ/∇ .



The current subtitle number and the total number of recorded subtitles are displayed in the box.

Example: 

The example above indicates that 3 subtitle languages are recorded in the disc and subtitle language 1 is being played back.

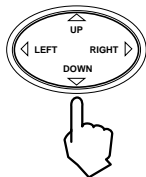

3. Change the subtitle using \triangle/\triangleright .
The subtitle language changes in numerical order.

Example: Selecting from three subtitle languages

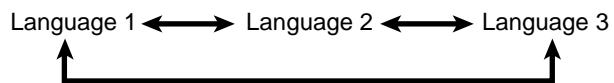

To turn off the on-screen display:

Press ON SCREEN.

Pressing it again turns on the on-screen display again.

Changing the audio

You can change the audio language or sound during playback.

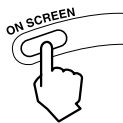

1. Press ON SCREEN during playback.
The on-screen display appears.

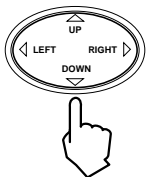

2. Move  to "AUDIO" using Δ/∇ .



The current audio channel number and the total number of recorded audio channels are displayed in the box.

Example: 

The example above indicates that 3 audio channels are recorded in the disc and audio channel 2 is being played back.

DVD Video Operations

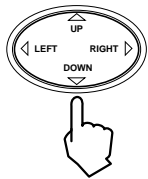

3. Change the audio channel using \triangle/\triangleright .
The audio channel changes in numerical order.

Example: Selecting from three audio channels

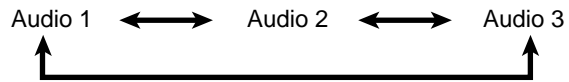

To turn off the on-screen display:

Press ON SCREEN.

Pressing it again turns on the on-screen display again.

Selecting picture character

You can select from three picture characters; sharp, soft and noise reduction.

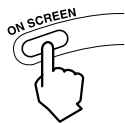

1. Press ON SCREEN during playback.
The on-screen display appears.

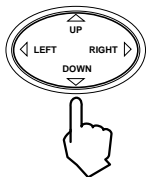

2. Move  to "PICTURE" using \triangle/∇ .



3. Select A, B, C using \triangle/\triangleright .

A: sharp
B: soft
C: noise reduction

- * You can set the picture characters for DVDs and video CDs independently.
- * The selection is memorized even if the player turns off and on.

To turn off the on-screen display:

Press ON SCREEN.

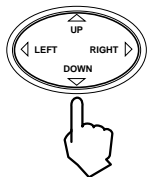

Down Mix

You can get the optimum stereo mix signals from DVD discs recorded with Dolby Digital surround multichannel audio, depending on your audio system by selecting DOWN MIX correctly.

You can change DOWN MIX setting only when playing back a DVD disc recorded with Dolby Digital surround multichannel audio.

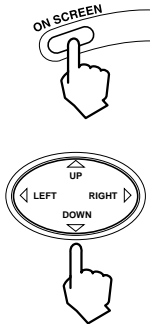

1. Press ON SCREEN during playback.
The on-screen display appears.

2. Move  to "DOWN MIX" using Δ/∇ .



3. Select from the following selections.

Lt/Rt: If you monitor the player's 2-channel audio output signals via an amplifier with built-in Dolby Pro Logic.

Lo/Ro: If you monitor the player's 2-channel audio output signals via a TV, an amplifier with no built-in Dolby Pro Logic, or the player's headphone jack. Or if you record DVD audio to a cassette tape, MD, etc.

OFF: If you monitor the player's 5.1-channel audio output signals via an amplifier equipped with Dolby Digital 5.1-channel inputs.

* Output signal from DIGITAL OUT

When setting "DIGITAL AUDIO OUTPUT" in the PREFERENCE on-screen display to "PCM ONLY" (see "Selecting Preferences" on page 53"), the same type of the signal as the analog 2 CH outputs is fed from the DIGITAL OUT. If you use DIGITAL OUT, select "DOWN MIX" to "Lt/Rt" or "L0/R0" according to the condition described above.

* If setting "DOWN MIX" to "OFF" while setting "CENTER SPEAKER" and "SURROUND SPEAKER" in the PREFERENCE on-screen display to "NONE", the same signal is output as setting to "Lt/Rt". (see "Selecting Preferences" on page 53")

* If "DOWN MIX" is not correctly selected, you may have a trouble in playing back a DVD disc recorded with the Dolby Digital surround multichannel audio as follows.

- Monitoring 2-channel audio with setting "DOWN MIX" to "OFF": Some material (such as dialog in a movie) may not be played back. (because channels except front L and R are not played back.)
- Monitoring 5.1-channel audio with setting "DOWN MIX" to "Lt/Rt" or "L0/R0": You cannot hear the sound from speakers except the front L and R. (because all sounds are mixed into front L and R.)

So if you connect both a Dolby Digital surround system and TV to the player and use one of them depending on the situation, you must be careful to set DOWN MIX correctly according to the playback system when playing back a Dolby Digital 5.1-channel source.

To turn off the on-screen display:

Press ON SCREEN.

Compression

Most DVD video discs recorded with Dolby Digital offer wider dynamic range than conventional VHS-videos or video CDs, which usually is too wide for a general home-use.

When setting "COMPRESSION" to "ON", audio is played back with dynamic range compressed. When "OFF", it is played back as it is recorded.

You can select ON or OFF of "COMPRESSION" only when the DOLBY DIGITAL 5.1 indicator on the player's front panel lights, which actually means the player is playing back a DVD disc recorded with Dolby Digital 5- or 5.1-channel surround audio in the Dolby Digital 5.1-channel playback system.

In other words, the following conditions are satisfied, the indicator lights.

- * In the preferences, "CENTER SPEAKER" and "SURROUND SPEAKERS" are set to "USE", and "BASS REDIRECT" is set to "SUB".
- * DOWN MIX is set to OFF.
- * The front panel display indicates the recorded channels as below.



recorded with 5 channel audio or recorded with 5.1 channel audio

In the other cases, the player automatically sets the COMPRESSION setting as below.

- * For a DVD disc recorded with linear PCM or MPEG audio: OFF
- * For a DVD disc recorded with up to 4-channel Dolby Digital audio: ON
- * For a DVD disc recorded with Dolby Digital 5- or 5.1-channel audio but the player's preferences are not set as above (=the speaker system does not contain all units for 5.1 channels: ON



1. Press ON SCREEN during playback.
The on-screen display appears.

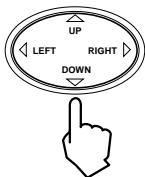

2. Move to "COMPRESSION" using Δ/∇ .



3. Turn compression ON or OFF using \triangle/∇ .

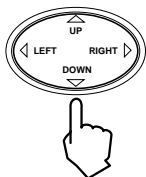

To turn off the on-screen display:
Press ON SCREEN.

Audio CD Operations

This chapter explains all the functions of the player for playing back audio CDs. Read "Basic Operations" on pages 22 and 23 before reading this chapter.

Playing back from a desired track

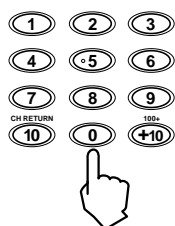
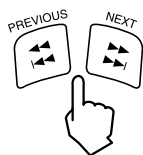

■ Using ◀◀/|◀◀, ▶▶/|▶▶ buttons during playback

Pressing ▶▶/|▶▶ causes the player to jump to the next track and start playback. Therefore, press ▶▶/|▶▶ as many times as required to jump to the desired track and start playback.

Similarly, pressing ◀◀/|◀◀ causes the player to jump to the beginning of the current track and start playback. By pressing it again, the player jumps to the previous track and starts playback.

■ Using numeric keys

You can also use the numeric keys on the remote control unit to select a track number. The player automatically starts playback from the selected track regardless of the player's mode.

See page 17 for details about how to use the numeric keys.

Resuming playback

The player can memorize a position on a disc you want to interrupt playback and resume playback from that position later.

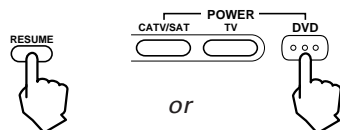

■ Memorizing a position

1. During playback, Press RESUME, or press POWER to turn off the power (STANDBY).

The player memorizes the current playback position of the disc, and the RESUME indicator on the front panel lights.

To clear the memory:

Take out the disc from the disc tray.

* The last memory overrides the previous memory.

■ Resuming playback

1. Press RESUME when the disc is stopped or the power is off (STANDBY).

The player will locate the memory position and start playback.



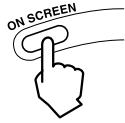

Playing back in a desired order

You can listen to the tracks on a CD in the order you want.

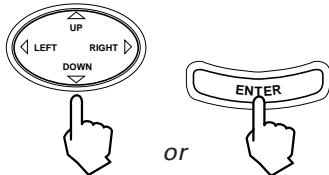

1. Press ON SCREEN while the disc is stopped.
The on-screen display appears.



2. Move  to "PROGRAM" using Δ/∇ and press ENTER.

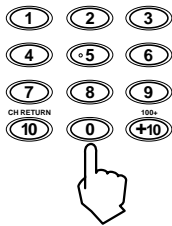

3. Select the tracks in the desired order using the numeric keys.

- * See page 17 for details about how to use the numeric keys. The entered numbers are displayed on the screen.
- * Up to 16 tracks can be programmed. You may select the same track more than once.

If you make a mistake:

Move  to CLEAR in the display using $\Delta/\nabla/\triangleright/\triangleleft$ and press ENTER. The last programmed track is deleted.

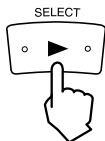

4. Press ▶ to start the program playback.

- * When all of the programmed tracks have finished playback, the player stops but the program remains.
- * Pressing ■ during the program playback makes the player stop but the program remains.

To quit the program mode:

Move  to "PROGRAM" in the display using $\Delta/\nabla/\triangleright/\triangleleft$ and press ENTER. "PROGRAM" returns to its original color.

Repeating all tracks

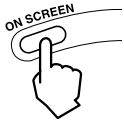

1. Press ON SCREEN.
The on-screen display appears.

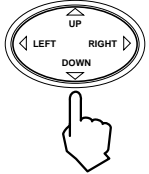

2. Move to "REPEAT" using Δ/∇ .



3. Press ENTER once.
"REPEAT ALL" is displayed and all tracks are played back repeatedly.

To stop playback

Press . The player stops but the All-track repeat mode remains.

To quit All-track Repeat:

Move to "REPEAT" in the on-screen display and press ENTER twice.
"REPEAT" returns to its original color.

Repeating a single track

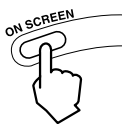

1. Press ON SCREEN during playback.
The on-screen display appears.

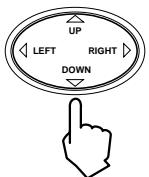

2. Move to "REPEAT" using Δ/∇ .



3. Press ENTER twice.
"REPEAT1" is displayed and the current track is played back repeatedly.

To stop playback

Press . The player stops but the Single repeat mode remains.

Audio CD Operations

To quit Single Repeat:

Move  to "REPEAT" in the on-screen display and press ENTER. "REPEAT" returns to its original color.

Repeating a desired part

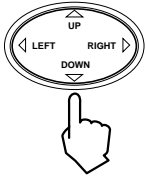

You can repeat a desired part in a CD.

1. Press ON SCREEN during playback.
The on-screen display appears.

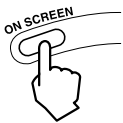

2. Move  to "A-B REPEAT" using Δ/∇ .

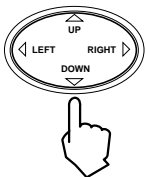

3. At the beginning of the desired part (point A), press ENTER.



To quit A-B Repeat:

Press ■. The player stops and quits the A-B repeat mode.

Starting playback from a specified time

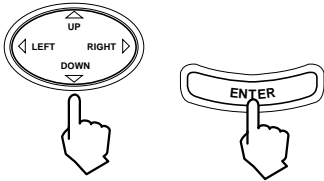

You can playback a disc from the desired position by specifying the elapsed time from the beginning of the disc.

(You have to know the corresponding elapsed time in advance. To know the elapsed time, see "Selecting the displayed time mode" on page 40.)

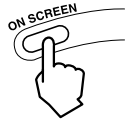

1. Press ON SCREEN.
The on-screen display appears.

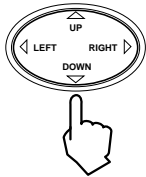

2. Move  to the "TIME SEARCH" using Δ/∇ .



Audio CD Operations

3. Press ENTER.

You can check the first 10 seconds of each track on a disc.

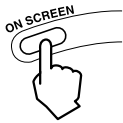

4. Press ON SCREEN while the disc is stopped. The on screen display appears. See page 17 for details about how to use the numeric keys.

2. Move  to "INTRO" using Δ/∇ .

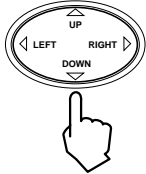

5. Move  to "TIME SELECT". The player starts.

If the specified time appears so that you can reenter the time.



Playing back only the beginning of each track



3. Press ENTER.

The first 10 seconds of each track on a disc are played back from the first track in numerical order. When all the tracks are played back, the player quits this function.

To quit this function during execution

Press .

Playing back tracks in random order

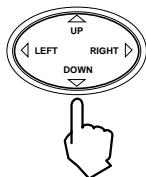
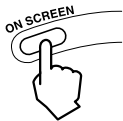



The player can playback tracks in random order.

1. Press ON SCREEN while the disc is stopped.
The on-screen display appears.

2. Move  to "RANDOM" using Δ/∇ .



3. Press ENTER.
The Random play begins.
When all tracks have been played once, the Random play quits.

* The same track will not be played back more than once during the Random play.

To quit this function during execution

Press ■.

Selecting the displayed time mode

Video CD Operations

This chapter explains all the functions of the player for playing back video CDs. Read "Basic Operations" on pages 22 and 23 before reading this chapter.

Playing back from a desired track

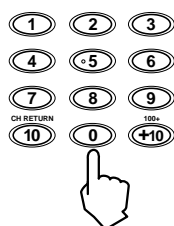

■ Using ◀◀/|◀◀, ▶▶/|▶▶ buttons during playback

Pressing ▶▶/|▶▶ causes the player to jump to the next track and start playback. Therefore, press ▶▶/|▶▶ as many times as required to jump to the desired track and start playback.

Similarly, pressing ◀◀/|◀◀ causes the player to jump to the beginning of the current track and start playback. By pressing it again, the player jumps to the previous track and starts playback.

* Note that this operation is disabled during playback with PBC.

■ Using numeric keys

You can also use the numeric keys on the remote control unit to select a track number. The player automatically starts playback from the selected track regardless of the player's mode.

See page 17 for details about how to use the numeric keys.

* Note that this operation is disabled during playback with PBC.

Advancing a picture frame-by-frame



You can advance a still picture frame-by-frame.

1. Press STEP during playback.

The player pauses.

Each time you press STEP, the picture advances one frame.

Pressing ▶ returns the player to normal playback.

* The audio is muted during frame-by-frame playback.

* You cannot backward a picture frame-by-frame.

Playing in slow-motion



You can playback a disc in slow-motion.

1. Press SLOW "+" during playback.

The playback speed slows down to half the normal speed.

Thereafter, each press of SLOW "+" slows the speed down to 1/3, 1/4, 1/8, 1/16 and 1/32 of the normal speed.

Pressing SLOW "-" speeds up in reverse order of the above.

Pressing ▶ returns the player to normal playback.

* Audio is muted during slow-motion playback.

* When the picture is being played back of 1/32 of the normal speed (which is the slowest) the SLOW "+" button is not effective.

* Similarly, "-" button is not effective during 1/2 speed playback.

* Pressing STEP or || in slow-motion mode freezes the motion.

Resuming playback

The player can memorize a position on a disc you want to interrupt playback and resume playback from that position later.

■ Memorizing a position

1. During playback, Press RESUME, or press POWER to turn off the power (STANDBY).

The player memorizes the current playback position of the disc, and the RESUME indicator on the front panel lights.

To clear the memory:

Take out the disc from the disc tray.

* The last memory overrides the previous memory.

■ Resuming playback

1. Press RESUME when the disc is stopped or the power is off (STANDBY).

The player will locate the memory position and start playback.

* The XV-D2000BK may resume playback from slightly before the memorized position if you operate when "PBC" is indicated in the front panel display.

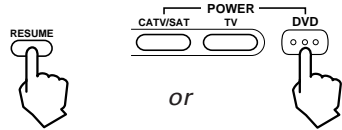

Playing back in a desired order

You can enjoy the tracks on a video CD in the order you want.

1. Press ON SCREEN while the disc is stopped.
The on-screen display appears.

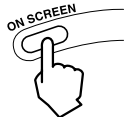

2. Move  to "PROGRAM" using Δ/∇ and press ENTER.

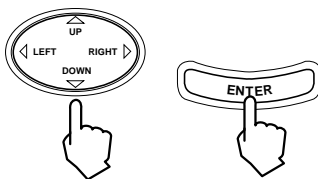

Video CD Operations

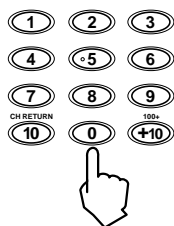

3. Select the tracks in the desired order using the numeric keys.

* See page 17 for details about how to use the numeric keys. The entered numbers are displayed on the screen.

* Up to 16 tracks can be programmed. You may select the same track more than once.

If you make a mistake:

Move to CLEAR in the display using $\Delta/\nabla/\triangleright/\triangleleft$ and press ENTER. The last programmed track is deleted.

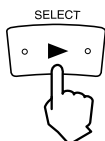

4. Press to start the program playback.

* When all of the programmed tracks have finished playback, the player stops but the program remains.

* Pressing during the program playback makes the player stop but the program remains.

To quit the program mode:

1. Press if the player is playing.
2. Press ON SCREEN to turn on the on-screen display.
3. Move to "PROGRAM" in the display using $\Delta/\nabla/\triangleright/\triangleleft$ and press ENTER. "PROGRAM" returns to its original color.

Repeating all tracks

* Note that this function cannot be used during playback with PBC. To use this function, press to stop playback and then specify any track number by using the numeric keys. (See "Playing back from a desired track" on page 42.)

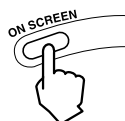

1. Press ON SCREEN during playback. The on-screen display appears.

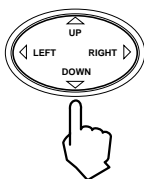

2. Move to "REPEAT" using Δ/∇ .



3. Press ENTER once. "REPEAT ALL" is displayed and all tracks are played back repeatedly.

To stop playback

Press . The player stops but the All-track repeat mode remains.

To quit All-track Repeat:

Move to "REPEAT" in the on-screen display and press ENTER twice. "REPEAT" returns to its original color.

To turn off the on-screen display:

Press ON SCREEN.



Repeating a single track

* Note that this function cannot be used during playback with PBC. To use this function, press ■ to stop playback and then specify a desired track number by using the numeric keys. (See "Playing back from a desired track" on page 42.)

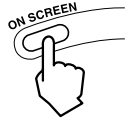

1. Press ON SCREEN during playback.
The on-screen display appears.

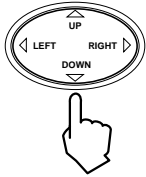

2. Move to "REPEAT" using Δ/∇ .



3. Press ENTER twice.
"REPEAT1" is displayed and the current track is played back repeatedly.



To stop playback

Press ■. The player stops but the Single repeat mode remains.

To quit Single Repeat:

Move to "REPEAT" in the on-screen display and press ENTER. "REPEAT" returns to its original color.

To turn off the on-screen display:

Press ON SCREEN.

Repeating a part

You can repeat a desired part in the current track.



1. Press ON SCREEN during playback.
The on-screen display appears.

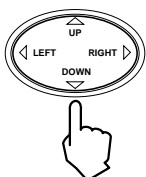

2. Move to "A-B REPEAT" using Δ/∇ .



Video CD Operations



3. At the beginning of the desired part (point A), press ENTER.

4. At the end of the desired part (point B), press ENTER.

The player locates "A" and starts playback between "A" and "B" repeatedly.

To quit A-B Repeat:

Press ■. The player stops and quits the A-B repeat mode.

To turn off the on-screen display:

Press ON SCREEN.

Starting playback from a specified time

You can playback a disc from the desired position by specifying the elapsed time from the beginning of the disc.

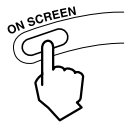

1. Press "ON SCREEN".

The on-screen display appears.

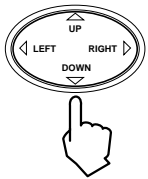

2. Move to "TIME SEARCH" using Δ/∇ .

If the playback is with the PBC function, stop the playback and do the same operation again.



For video CD during stop



For video CD during playback



3. Press ENTER if the disc is in stop.

Skip this process if you are operating during playback.

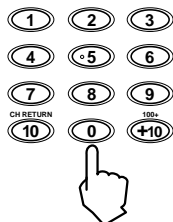

4. Enter a desired time using the numeric keys on the remote control unit.

See page 17 for details about how to use the numeric keys.

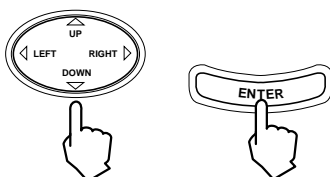

5. Move to "TIME SEARCH" using Δ/∇ and press ENTER.

The player starts playback from the specified time.

If the specified time does not exist, the entered number disappears so that you can reenter the time.

Playing back only the beginning of each track

You can check the first 10 seconds of each track on a disc.

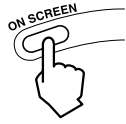

1. Press ON SCREEN while the disc is stopped.
The on-screen display appears.

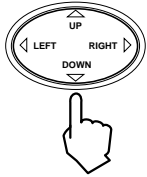

2. Move  to "INTRO" using Δ/∇ .



3. Press ENTER.
The first 10 seconds of each track on a disc are played back from the first track in numerical order. When all the tracks are played back, the player quits this function.

To quit this function during execution

Press .

Playing back tracks in random order

The player can playback tracks in random order.

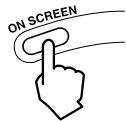

1. Press ON SCREEN while the disc is stopped.
The on-screen display appears.

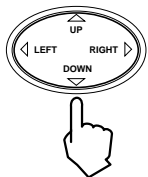

2. Move  to "RANDOM" using Δ/∇ .



Video CD Operations



3. Press ENTER.
The Random play begins.
When all tracks have been played once, the Random play quits.

* The same track will not be played back more than once during the Random play.

Selecting audio channels

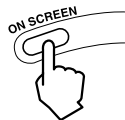

1. Press ON SCREEN during playback.
The on-screen display appears.

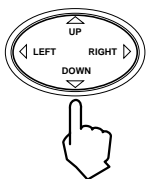

2. Move  to AUDIO using Δ/∇ .



3. Select the audio channel(s) to be played back using $\triangleleft/\triangleright$.

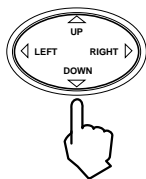

- LR: You will hear normal stereo playback.
- L: You will hear L (Left) channel signal played back from both left and right speakers.
- R: You will hear R (Right) channel signal played back from both left and right speakers.

Selecting picture character

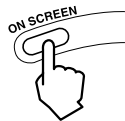

You can select from three picture characters; sharp or soft and noise reduction.

1. Press "ON SCREEN" during playback.
The on-screen display appears.

2. Move  to "PICTURE" using Δ/∇ .

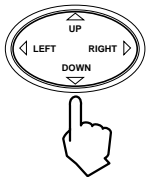

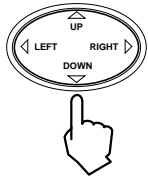

3. Select A, B, C using \triangle/∇ .

- A: sharp
- B: soft
- C: noise reduction

- * You can set the picture characters for DVDs and video CDs independently.
- * The selection is memorized even if the player turns off and on.

To turn off the on-screen display:

Press ON SCREEN.

Checking total disc time

You can see the total disc time in the on-screen display and the front panel display while the disc is stopped.

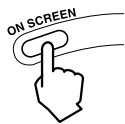

1. Press ON SCREEN while the disc is stopped.
The on-screen display appears.

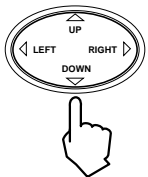

2. Move  to "TIME SELECT" using \triangle/∇ .



3. Press ENTER until "TOTAL REMAIN" is selected as the display time mode.

- * During playback, the elapsed time of the current track is displayed regardless of the setting above.



Accessing the PBC function

When the player is playing back a video CD without using the PBC (Playback Control) function (such cases include playback of the track specified with the numeric keys), you can go into the PBC mode by two methods.

Method 1:

1. Press .

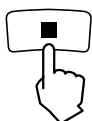

2. Press .

The player starts the PBC function.

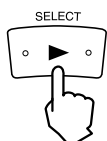

Method 2:

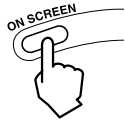

1. Press ON SCREEN during playback.
The on-screen display appears.

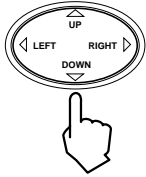

2. Move  to "PBC CALL" using Δ/∇ .



3. Press ENTER.
The player starts the PBC function.



If appears:

The disc does not support PBC or it is being played back in PBC mode.

Controlling Other Equipment

The remote control unit supplied with the player can control other manufacturers' TVs, CATV converters and satellite tuners, as well as JVC's amplifiers/receivers.

When operating the other manufacturers' components, refer to the manuals supplied with them. To operate these components with the remote control, first you need to set the manufacturers' code for each TV, CATV converter, or satellite tuner.

When using the remote control, make sure that the DVD/TV/CATV selector is set to the correct position.

Controlling TV

To change the remote control signals for operating another manufacturer's TV

1. Set the DVD/TV/CATV selector to the "TV" position.

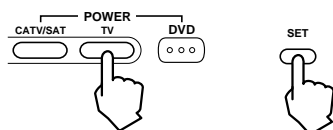

2. Press and hold POWER-TV, then press SET. Do not release POWER-TV. Keep holding POWER-TV until the next step is completed.

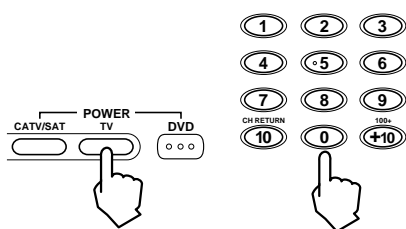

3. Holding POWER-TV, enter the manufacturer's code (two digits) using numeric buttons 1-9, and 0. See the lists on page 61 to find the manufacturer's code.

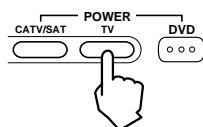

4. Release POWER-TV. The following buttons can be used for operating the TV (with the DVD/TV/CATV selector set to "TV" position):

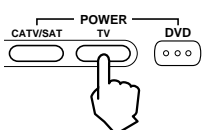

- POWER-TV: Turns the TV on and off.
- CH +/-: Changes the channels.
- TV VOLUME +/-: Adjusts the volume.
- 1-9, 0, 100+(+10): Selects the TV channels. +10 button will function as the ENTER button if your TV requires pressing ENTER after selecting a channel number.
- TV/VIDEO: Sets the input mode (either TV or VIDEO).
- 10 (CH RETURN): Returns to the previous channel. (only valid for JVC TVs)
- MUTE: Mutes the TV sound.

Note: Refer also to the manual supplied with your TV.

5. Try to operate your TV by pressing POWER-TV. If your TV turns on or off, you have entered the correct code.

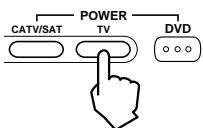

Note: If there is more than one code listed for your brand of TV, try each one until the correct one is entered.

Controlling CATV converter or satellite tuner

To change the Remote Control signals for operating a CATV converter or satellite tuner



1. Set the DVD/TV/CATV selector to the "CATV" position.
2. Press and hold POWER-CATV/SAT, then press SET.
Do not release POWER-CATV/SAT. Keep holding POWER-CATV/SAT until the next step is completed.
3. Holding POWER-CATV/SAT, enter the manufacturer's code (two digits) using numeric buttons 1-9, and 0.
See the lists on page 61 to find the manufacturer's code.

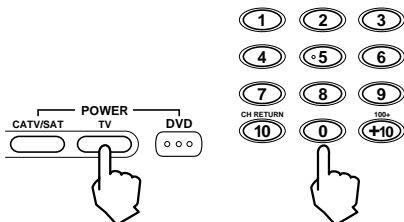

4. Release POWER-CATV/SAT.
The following buttons can be used for operating the CATV converter or satellite tuner (with DVD/TV/CATV selector set to "CATV" position):
 - POWER-CATV/SAT: Turns on and off the CATV converter or satellite tuner.
 - CH +/-: Changes the channels.
 - 1-9, 0: Selects the TV channels. (See "How to use numeric keys" on page 17)

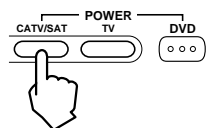

Note: Refer also to the manual supplied with your CATV converter or satellite tuner.

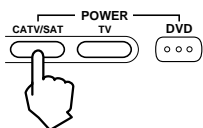

5. Try to operate your CATV converter or satellite tuner by pressing POWER-CATV/SAT.
If your CATV converter or satellite tuner turns on or off, you have entered the correct code.

Note: If there is more than one code listed for your brand of CATV converter or satellite tuner, try each one until the correct one is entered.

Controlling a JVC amplifier or receiver

AUDIO VOLUME controls the volume of a JVC amplifier or receiver.

Selecting Preferences

You can set various preferences mainly related with DVD playback via the "PREFERENCE" and "PARENTAL LOCK" on-screen displays.

Preferences via "PREFERENCE" on-screen display

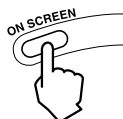

How to set up

1. Take out the disc from the disc tray.
You do not have to take out the disc if it is a DVD disc, but press ■ to make it stop.
Close the disc tray before setting up.

2. Press ON SCREEN.
The "PREFERENCE" on-screen display appears on the television screen.

* The "PREFERENCE" consists of two pages.

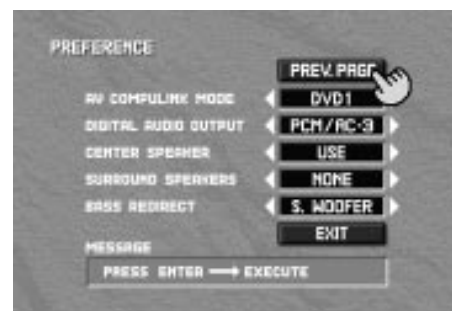

To turn the page of the on-screen display:

Move  to "NEXT PAGE" or "PREV PAGE" using Δ/∇ and press ENTER.

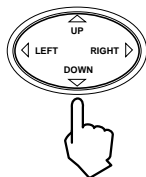
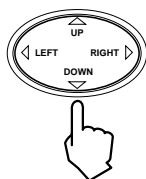

3. Move  to the item to be set using Δ/∇ .

4. Select the setting you prefer using \triangle/\triangleright .

To turn off the on-screen display:

Press ON SCREEN.

■ Items

The following preferences can be set.

MENU LANGUAGE

You can select the default "DVD menu" language to be displayed if the disc contains it.

Each time you press \triangleright , the setting language changes as follows.

ENGLISH → SPANISH → FRENCH → CHINESE → GERMAN → ITALIAN → JAPANESE → language code from AA to ZU (See "Table of languages and their abbreviations" on page 60.)

Pressing \triangleleft changes the setting language in the reverse order of the above.

* If the selected language is not played, the disc's default menu language is displayed.

AUDIO LANGUAGE

Up to eight audio languages can be recorded in a DVD disc. You can select the default audio language to be played if the disc contains it.

Each time you press \triangleright , the setting language changes as follows.

ENGLISH → SPANISH → FRENCH → CHINESE → GERMAN → ITALIAN → JAPANESE → language code from AA to ZU (See "Table of languages and their abbreviations" on page 60.)

Pressing \triangleleft changes the setting language in the reverse order of the above.

* If the selected language is not recorded, the disc's default audio language is reproduced.

SUBTITLE

Up to 32 subtitle languages can be recorded in a DVD disc. You can select the default subtitle language to be displayed if the disc contains it.

Each time you press \triangleright , the setting language changes as follows.

ENGLISH → SPANISH → FRENCH → CHINESE → GERMAN → ITALIAN → JAPANESE → language code from AA to ZU (See "Table of languages and their abbreviations" on page 60.)

Pressing \triangleleft changes the setting language in the reverse order of the above.

* If the selected language is not recorded, the disc's default subtitle language is displayed.

ON SCREEN GUIDE

The player can display "on screen guide" icons or characters on the picture, which show what is happening to the disc or the player.

You can turn the guide display on or off.

MONITOR TYPE

You can select a monitor type when you playback DVD discs recorded for wide screen televisions.

If your television has a normal (4:3) screen, select "4:3 PS " (cuts both sides of the "wide" picture) or "4:3 LB " (with masking bars to maintain the "wide" aspect ratio).

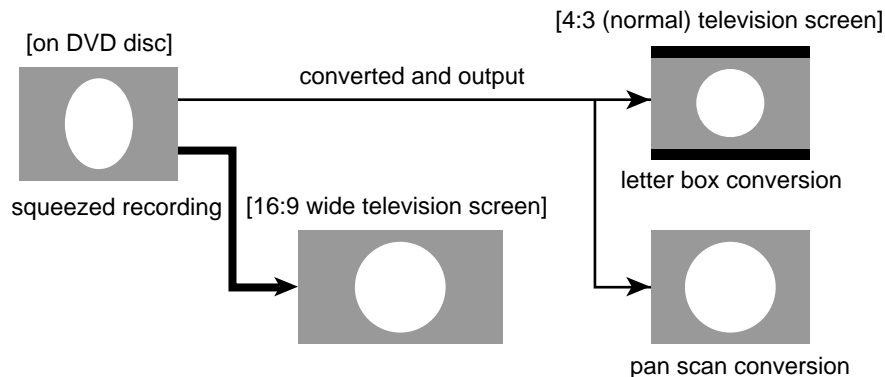

If your television has a wide (16:9) screen, you have to select "16:9 WIDE".

AV COMPULINK MODE

If you use the AV Compulink system, you must set this item correctly.

Select from the three options: DVD1, DVD2 and DVD3 according to the equipment to be connected.

See "AV Compulink remote control system" on pages 62.

DIGITAL AUDIO OUTPUT

To connect the player's digital output with an external amplifier or receiver equipped with a digital input, this item must be set correctly.

PCM ONLY: to connect to a PCM digital input of a piece of audio equipment.

PCM/AC-3: to connect to a Dolby digital input of a Dolby Digital decoder or an amplifier with built-in Dolby Digital decoder.

The following chart shows the relationship between kinds of playback discs and output signals.

Playback discs	Output (PCM/AC-3 mode)	Output (PCM ONLY mode)
DVD with 48-kHz, 16-bit linear PCM	48-kHz, 16-bit linear PCM	←
DVD with 48-kHz, 20/24-bit linear PCM	48-kHz, 20-bit linear PCM	←
DVD with 96-kHz, linear PCM	no output	←
DVD with Dolby Digital	Dolby Digital bitstream	48-kHz, 16-bit linear PCM
DVD with MPEG audio	48-kHz, 16-bit linear PCM	←
CD	44.1-kHz, 16-bit linear PCM	←
Video CD	44.1-kHz, 16-bit linear PCM	←

CENTER SPEAKER

When the player is connected to an AV amplifier with Dolby Digital 5.1-channel inputs;

- set to "USE" if the system includes a center speaker.
- set to "NONE" if the system does not include a center speaker.

The audio output balance between 5.1-channel outputs is adjusted according to the setting above.

You do not need to select this item when using the 2 CH outputs or DIGITAL OUT.

SURROUND SPEAKERS

When the player is connected to an AV amplifier with Dolby Digital 5.1-channel inputs;

- set to "USE" if the system includes surround speakers.
- set to "NONE" if the system does not include surround speakers.

The audio output balance between 5.1-channel outputs is adjusted according to the setting above.

You do not need to select this item when using the 2 CH outputs or DIGITAL OUT.

BASS REDIRECT

It controls the low frequency output of Dolby Digital.

- set to "SUB" if the player is used in a system including a sub-woofer. With this setting, low-frequency signals in the C, LS and RS channels are fed from the sub-woofer output if the DVD video disc does not contain the sub-woofer channel signal in the Dolby Digital bitstream.
- set to "L/R" if the player is used in a system with no sub-woofer. With this setting, low-frequency signals in the C, LS and RS channels are added to the L and R outputs if the DVD video disc does not contain the sub-woofer channel signal in the Dolby Digital bitstream.

You do not need to select this item when using the 2 CH outputs or DIGITAL OUT.

Setting Parental Lock

The Parental Lock is one of the special features of DVD. It restricts playback of DVD discs which contains violent (and other) scenes according to the level set by the user. For example, by setting the Parental level strictly, when a movie which includes violent scenes is played back, the scenes are cut or replayed with other scenes in order not to be seen by children.

With the XV-D2000BK, you can set or modify its level and password via the Parental Lock on-screen display.

Setting for the first time

1. While holding down ■, press ENTER on the remote control unit.
The Parental Lock on-screen display appears.



2. Select the parental level using </> .
You can select the level from among NONE, NC17, R, PG13, PG, and G.
You cannot playback DVD discs rated higher than the selected level.
NONE means no restriction. NC17 is the strictest.

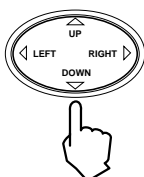



3. Press ENTER.



4. Enter your 4-digit password using the numeric keys.



5. Press ENTER.

The parental level and your password are set.

Changing the settings



1. While holding down ■, press ENTER on the remote control unit.
The Parental Lock on-screen display appears.

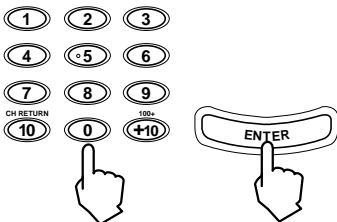

2. Enter your 4-digit password using the numeric keys and press ENTER.
If you enter a wrong password, the following message appears in the message box.
"WRONG! RETRY....."

If you forget your password:

Enter "8888".

After entering the correct password, proceed to the following steps.

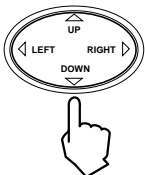

3. Select the parental level using </> .



4. Press ENTER.
The level is changed.

Selecting Preferences

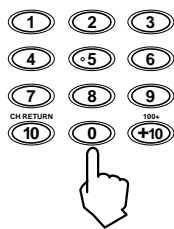

5. Enter a new password using numeric keys.

6. Press ENTER.
The new setting is effective.

Temporary release of the Parental lock

When the parental level is set strictly, some discs may not be played back at all. When you insert such a disc and try to play it, the player will ask you whether you want the parental lock to be released temporarily or not.



If you select "YES", then enter your password, the disc will start playback.

If you enter a wrong password, the following message appears.
"WRONG! RETRY....."

If you select "NO", the parental lock on-screen display disappears.

Other Information

Care and handling of discs

How to handle discs

When handling a disc, do not touch the surface of the disc (reflective silver side — the side without the label).

Since discs are made of plastic, they are easily damaged. If a disc gets dirty, dusty, scratched or warped, the images and sound will not be picked up correctly, and such a disc may cause the player to malfunction.

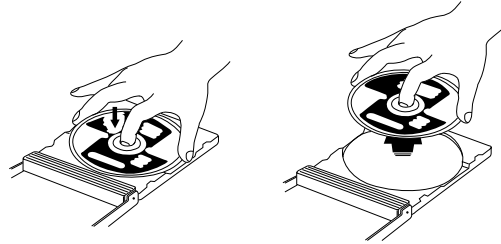

Even on label side

Do not damage the label side, stick paper to or use any adhesive on its surface.

Storage

Make sure that discs are kept in their cases. If discs are piled on top of one another without their protective cases, they can be damaged. Do not put discs in a location where they may be exposed to direct sunlight, or in a place where the humidity or temperature is high. Avoid leaving discs in your car!

Maintenance of discs

If there are fingerprints or other dirt adhering to a disc, wipe with a soft dry cloth, moving from the center outwards.

If a disc is difficult to clean, wipe with a cloth moistened with water. Never use record cleaners, petrol, alcohol or any anti-static agents.

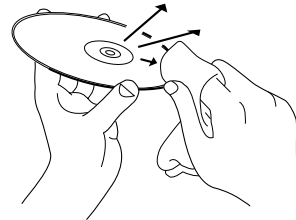

CAUTION

Sometimes during play noise or images may be garbled. This is sometimes due to the disc. (It may not be up to industry standards.)

These symptoms are caused by the discs, not by the malfunction of the player.

Table of languages and their abbreviations

AA	Afar
AB	Abkhazian
AF	Afrikaans
AM	Ameharic
AR	Arabic
AS	Assamese
AY	Aymara
AZ	Azerbaijani
BA	Bashkir
BE	Byelorussian
BG	Bulgarian
BH	Bihari
BI	Bislama
BN	Bengali, Bangla
BO	Tibetan
BR	Breton
CA	Catalan
CO	Corsican
CS	Czech
CY	Welsh
DA	Danish
DZ	Bhutani
EL	Greek
EO	Esperanto
ET	Estonian
EU	Basque
FA	Persian
FI	Finnish
FJ	Fiji
FO	Faroese
FY	Frisian
GA	Irish
GD	Scots Gaelic
GL	Galician
GN	Guarani
GU	Gujarati
HA	Hausa
HI	Hindi
HR	Croatian
HU	Hungarian
HY	Armenian
IA	Interlingua
IE	Interlingue

IK	Inupiak
IN	Indonesian
IS	Icelandic
IW	Hebrew
JI	Yiddish
JW	Javanese
KA	Georgian
KK	Kazakh
KL	Greenlandic
KM	Cambodian
KN	Kannada
KO	Korean (KOR)
KS	Kashmiri
KU	Kurdish
KY	Kirghiz
LA	Latin
LN	Lingala
LO	Laothian
LT	Lithuanian
LV	Latvian, Lettish
MG	Malagasy
MI	Maori
MK	Macedonian
ML	Malayalam
MN	Mongolian
MO	Moldavian
MR	Marathi
MS	Malay (MAY)
MT	Maltese
MY	Burmese
NA	Nauru
NE	Nepali
NL	Dutch
NO	Norwegian
OC	Occitan
OM	(Afan) Oromo
OR	Oriya
PA	Panjabi
PL	Polish
PS	Pashto, Pushto
PT	Portuguese
QU	Quechua
RM	Rhaeto-Romance

RN	Kirundi
RO	Rumanian
RU	Russian
RW	Kinyarwanda
SA	Sanskrit
SD	Sindhi
SG	Sangho
SH	Serbo-Croatian
SI	Singhalese
SK	Slovak
SL	Slovenian
SM	Samoan
SN	Shona
SO	Somali
SQ	Albanian
SR	Serbian
SS	Siswati
ST	Sesotho
SU	Sundanese
SV	Swedish
SW	Swahili
TA	Tamil
TE	Telugu
TG	Tajik
TH	Thai
TI	Tigrinya
TK	Turkmen
TL	Tagalog
TN	Setswana
TO	Tonga
TR	Turkish
TS	Tsonga
TT	Tatar
TW	Twi
UK	Ukrainian
UR	Urdu
UZ	Uzbek
VI	Vietnamese
VO	Volapuk
WO	Wolof
XH	Xhosa
YO	Yoruba
ZU	Zulu

Manufacture's code list

■ TV

No.	Manufacturer
01	JVC
02	MAGNAVOX
03	MITSUBISHI
04	PANASONIC
05	RCA
06	SHARP
07	SONY
08	TOSHIBA
09	ZENITH
10	HITACHI
11	PANASONIC
12	SAMSUNG
13	SANYO
14	SANYO
15	SAMSUNG

■ CATV/SAT

No.	Manufacturer
01	GI JERROLD
02	GI JERROLD
03	GI JERROLD
04	GI JERROLD
05	GI JERROLD
06	GI JERROLD
07	GI JERROLD
08	GI JERROLD
09	SCIENTIFIC ATRANTA
10	SCIENTIFIC ATRANTA
11	ZENITH
12	ZENITH
13	PIONEER
14	PIONEER
15	HAMLIN/REGAL
16	HAMLIN/REGAL
17	HAMLIN/REGAL
18	HAMLIN/REGAL
19	OAK/SIGMA
20	OAK/SIGMA
21	OAK/SIGMA
22	TOCOM
23	TOCOM
24	RCA/PANASONIC
25	RCA/PANASONIC
26	RCA/PANASONIC
27	RCA(SAT)
28	SONY(SAT)

AV COMPULINK remote control system

When you buy a separate TV, VCR DVD player, receiver or other components and connect them to each other, you have to operate each component individually. JVC's AV COMPULINK remote control system meets the demand for a system made up of single components and has the ease of operation of a single unit.

■ Operation

You can enjoy pictures and/or sound by just putting a source component (which plays back the pictures and/or sound such as a DVD player or VCR) into play mode. You do not have to operate the TV and receiver including power switching.

1. Turn on the main power of the television.
2. Insert a disc into the source component.
3. Press ► of the source component.

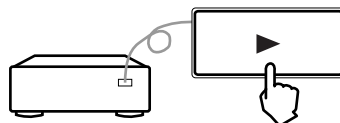

The following actions are performed automatically:

- Turning on the power of the television.
- Setting the source of the television to the external input (VIDEO 1 or VIDEO 2).
- Turning on the power of the receiver.
- Setting the source of the receiver to the component which has just started playback.

■ Connection and Setup

Using the AV COMPULINK cable, connect the AV COMPULINK terminals of each component to one another.

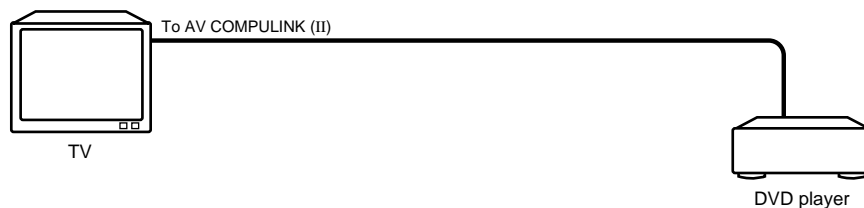

If you connect a DVD player with a television via AV COMPULINK, set the DVD player's AV COMPULINK setting as follows.

- When connecting with VIDEO 1 input terminal of the television: DVD2
- When connecting with VIDEO 2 input terminal of the television: DVD3

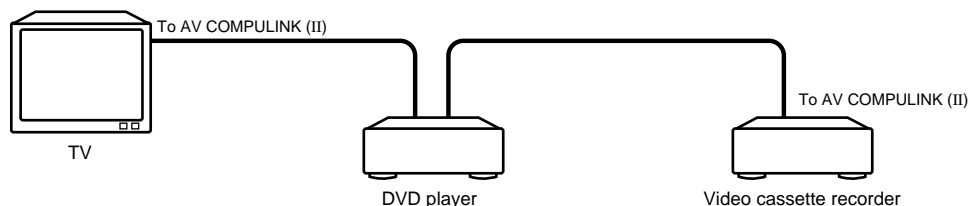

If you connect a DVD player with a television and VCR via AV COMPULINK, set the VCR's Remote Control Code and DVD player's AV COMPULINK setting as follows.

- When connecting with VIDEO 1 input terminal of the television:
DVD player's AV COMPULINK setting: DVD2
VCR's Remote Control Code: B
- When connecting with VIDEO 2 input terminal of the television:
DVD player's AV COMPULINK setting: DVD3
VCR's Remote Control Code: A

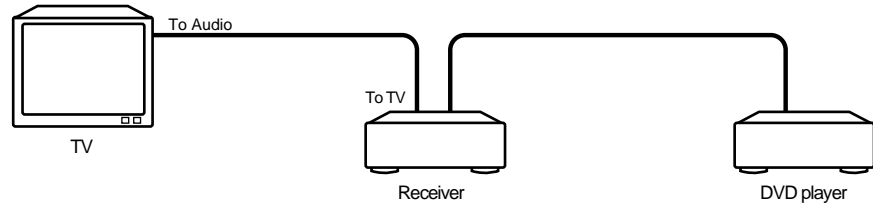

If you connect a DVD player with a television and receiver via AV COMPULINK, set the DVD player's AV COMPULINK setting to DVD1.

The DVD player's AV COMPULINK setting is operated in the "PEFERENCE" on-screen display. See "Preferences via "PEFERENCE" on-screen display" on pages 53 for operation.

Notes for connection

- If you connect a DVD player with a receiver via AV COMPULINK in a system including a Dolby digital decoder, some functions may not be done automatically.
- The AV COMPULINK terminal on some televisions indicates "II". Do not connect the terminal indicating "II" with the AV COMPULINK terminal on a receiver. If connected, the system will not work correctly.
- Connect the AUDIO OUT jacks of the DVD player to the audio input jacks of a receiver indicating "DVD". Otherwise, the system will not work correctly.

There is no description about connections to a DVD player in the instruction manual of a television or VCR. But a television or VCR with AV COMPULINK terminals indicating II can be connected to a DVD player.

Troubleshooting

What appears to be a malfunction may not always be serious. Please go through the following list before requesting service.

Symptom	Possible cause	Remedy
Power does not come on.	Power plug is not inserted securely.	Plug in securely.
Remote control does not work.	Too far from the player.	Come closer to the player.
	The tip of the remote unit is not pointed in the right direction.	Point the infrared light-emitting window toward the remote sensor on the front panel.
	Batteries are exhausted.	Replace the batteries with new ones.
	Battery polarity is incorrect.	Take out the batteries and insert them again in the correct direction.
No picture is displayed on the monitor.	Connection of video cable is incorrect.	Connect the cable correctly (see page 9).
	Input selection of TV is incorrect.	Select correctly.
	Disc is not playable.	(See page 16.)
No audio is reproduced.	Connection to stereo system is incorrect.	Check connections (see Page 9 to 13).
	Input selection of amplifier is incorrect.	Select correctly.
No sound from headphones.	PHONES LEVEL is too low.	Adjust the PHONE LEVEL.
Sound is distorted or noise is generated. Picture is garbled.	Disc is dirty.	Wipe the disc surface (see page 59).
	player is connected to a VCR.	Connect player with the TV directly.
Picture does not fit with the television screen.	MONITOR TYPE is not correctly set.	See "MONITOR TYPE" on page 55.
	Television is not correctly set.	Set the television correctly.
Operation is not possible.	Microcomputer malfunctions due to lightning or static electricity.	Turn off the power, then connect the power cord again.
	Moisture condensation occurs by sudden change of temperature or humidity.	Turn off the power, then turn it on a few hours later.
The TV speakers do not reproduce dialogs for a DVD movie disc.	DOWN MIX is set to OFF.	Set DOWN MIX to L0/R0 (see page 33).

There may be causes other than the player. Check the other devices connected to the player.

Specifications

General

Readable discs:	DVD video, CD, Video CD
Video format:	NTSC color

Other

Power requirements:	AC 120V \sim , 60Hz
Power consumption:	30 W (POWER ON), 5 W (STANDBY mode)
Mass:	4.8 kg (10.6 lbs)
Dimensions (W x H x D):	435 x 112 x 327.5 mm 17-3/16 x 4-7/16 x 12-15/16 inch

Video output

VIDEO OUT (pin jack):	1.0 Vp-p (75 ohms)
S-VIDEO OUT (S jack):	Y Output: 1.0 Vp-p (75 ohms), C Output: 286 mVp-p (75 ohms)
Horizontal resolution	500 Lines
Signal to noise ratio	65 dB

Audio output

ANALOG OUT (pin jack):	
Front	2.0 Vrms (10 k ohms)
Rear	2.0 Vrms (10 k ohms)
Center	2.0 Vrms (10 k ohms)
Sub woofer (BASS REDIRECT = "L/R")	
(NORMAL)	1.0 Vrms (5 k ohms)
(GAIN PLUS)	2.0 Vrms (10 k ohms)
2CH (ATT. OFF)	2.0 Vrms (10 k ohms)
2CH (ATT. ON)	1.0 Vrms (5 k ohms)
DIGITAL OUT:	
OPTICAL	-21 to -15 dBm (Peak)
COAXIAL	0.5 Vp-p

Audio characteristics

Frequency response:	CD (sampling frequency 44.1 kHz): 2 Hz to 20 kHz DVD (sampling frequency 48 kHz): 2 Hz to 22 kHz DVD (sampling frequency 96 kHz): 2 Hz to 44 kHz
Dynamic range:	16 bit: More than 99 dB 20 bit: More than 108 dB 24 bit: More than 108 dB
Wow and flutter:	Unmeasurable (less than \pm 0.002%)
Total harmonic distortion:	Less than 0.002%

* Specifications and appearance subject to change without prior notice.

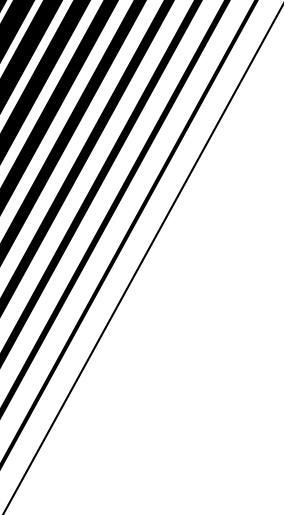

JVC
VICTOR COMPANY OF JAPAN, LIMITED